

# **OPERATING MANUAL**

## **INSULATION RESISTANCE METER**

**MIC-2501**

# MIC-2501

Input  $R_{iso+}$ : measurement of  $R_{iso}$ ,  $R_{cont}$  and U  
 Input  $R_{iso-}$ : measurement of  $R_{iso}$ ,  $R_{cont}$  and U  
 Input of shielding conductor G: three-lead measurement of  $R_{iso}$

**START** - starting the measurement procedure

**ESC** - return to previous function, exit the function, interrupting the measurement

12V power socket and a USB socket on the side of the housing

**SET/SEL** - selecting additional meter's settings

LED's indicating the selected measurement function

**ENTER** - approving selected function

Functional keys (cursors) - shift/selection: right/left, up/down

Turning power supply and screen backlight ON/OFF

**Function switching buttons**  
 Selecting the measurement function:

- $R_{iso}$  - measurement of insulation resistance with test voltage adjusted within the range of 100 V...2500 V,
- $R_{cont}$  - measurement of circuit continuity,
- U - measuring voltage up to 750V,
- MEM - viewing memory data





## **OPERATING MANUAL**

# **INSULATION RESISTANCE METER MIC-2501**



**SONEL S.A.  
ul. Wokulskiego 11  
58-100 Świdnica, Poland**

Version 1.03 10.10.2016

MIC-2501 meter is a modern, high quality, easy to use and safe measuring device. Please acquaint yourself with this manual in order to avoid measuring errors and prevent possible problems in operation of the meter.

# CONTENTS

<b>1</b>	<b>SAFETY .....</b>	<b>5</b>
<b>2</b>	<b>TURNING THE METER ON AND ACTIVATING SCREEN BACKLIGHT. .6</b>	
<b>3</b>	<b>METER CONFIGURATION.....</b>	<b>6</b>
<b>4</b>	<b>MEASUREMENTS.....</b>	<b>8</b>
4.1	MEASUREMENT OF INSULATION RESISTANCE .....	8
4.1.1	Double-lead measurement .....	8
4.1.2	Three-lead measurement .....	13
4.2	LOW-VOLTAGE MEASUREMENT OF RESISTANCE.....	15
4.2.1	Measurement of resistance of protective conductors and equipotential bonding with 200 mA current .....	15
4.2.2	Compensation of test leads resistance .....	16
4.3	VOLTAGE MEASUREMENT .....	17
<b>5</b>	<b>MEMORY OF MEASUREMENT RESULTS .....</b>	<b>18</b>
5.1	STORING THE MEASUREMENT RESULTS IN THE MEMORY .....	18
5.2	VIEWING MEMORY DATA .....	20
5.3	DELETING MEMORY DATA.....	21
5.3.1	Deleting bank data.....	21
5.3.2	Deleting the whole memory .....	22
<b>6</b>	<b>DATA TRANSMISSION.....</b>	<b>24</b>
6.1	COMPUTER CONNECTION ACCESSORIES .....	24
6.2	DATA TRANSMISSION THROUGH USB PORT.....	24
<b>7</b>	<b>SOFTWARE UPDATES.....</b>	<b>24</b>
<b>8</b>	<b>POWER SUPPLY .....</b>	<b>25</b>
8.1	MONITORING THE POWER SUPPLY VOLTAGE .....	25
8.2	CHARGING THE BATTERY PACK .....	25
8.3	GENERAL PRINCIPLES REGARDING USING NI-MH RECHARGEABLE BATTERIES .....	26
<b>9</b>	<b>CLEANING AND MAINTENANCE .....</b>	<b>27</b>
<b>10</b>	<b>STORAGE .....</b>	<b>27</b>
<b>11</b>	<b>DISMANTLING AND DISPOSAL .....</b>	<b>27</b>
<b>12</b>	<b>TECHNICAL SPECIFICATIONS.....</b>	<b>28</b>
12.1	BASIC DATA.....	28
12.2	ADDITIONAL DATA.....	30
12.2.1	Additional uncertainties according to IEC 61557-2 (R <sub>ISO</sub> ).....	30
12.2.2	Additional uncertainties according to IEC 61557-4 (R ±200 mA) .....	30

<b>13</b>	<b>ACCESSORIES.....</b>	<b>30</b>
13.1	<i>STANDARD EQUIPMENT .....</i>	<i>30</i>
13.2	<i>OPTIONAL ACCESSORIES.....</i>	<i>30</i>
<b>14</b>	<b>MANUFACTURER .....</b>	<b>31</b>
<b>15</b>	<b>LABORATORY SERVICES .....</b>	<b>32</b>

# 1 Safety

MIC-2501 meter is designed for performing check tests of protection against electric shock in mains systems. The meter is used for making measurements and providing results to determine safety of electrical installations. Therefore, in order to provide conditions for correct operation and accuracy of obtained results, the following recommendations must be observed:

- Before you proceed to operate the meter, acquaint yourself thoroughly with the present manual and observe the safety regulations and specifications provided by the producer.
- Any application that differs from those specified in the present manual may result in a damage to the device and constitute a source of danger for the user.
- MIC-2501 meters must be operated only by appropriately qualified personnel with relevant certificates authorising the personnel to perform works on electric systems. Unauthorized use of the meter may result in its damage and may be a source of serious hazard to the user.
- During measurements of insulation resistance, dangerous voltage of approx. 2.5kV occurs at the ends of measurement wires of the meter.
- Before the measurement of insulation resistance you must be sure that tested object is disconnected from the power supply.
- During the measurement of insulation resistance do not disconnect test leads from the tested object before the measurement is completed (see par. 4.1); otherwise the capacitance of the object will not be discharged, creating the risk of electric shock.
- Using this manual does not exclude the need to comply with occupational health and safety regulations and with other relevant fire regulations required during the performance of a particular type of work. Before starting the work with the device in special environments, e.g. potentially fire-risk/explosive environment, it is necessary to consult it with the person responsible for health and safety.
- It is unacceptable to operate the device when:
  - ⇒ a damaged meter which is completely or partially out of order,
  - ⇒ a meter with damaged insulation,
  - ⇒ a meter stored for an excessive period of time in disadvantageous conditions (e.g. excessive humidity). If the meter has been transferred from a cool to a warm environment with a high level of relative humidity, do not start measurements until the meter is warmed up to the ambient temperature (approximately 30 minutes).
- Remember that **bAt** message appearing on the display indicates insufficient voltage of power supply and the need to recharge the batteries.
- Message **ErrX** displayed in the main field, where **X** is a number from 0 to 9, indicate incorrect operation of the meter. If after restarting the device this situation is repeated - it indicates that the meter is damaged. Please contact the manufacturer's service.
- Before measurement, choose a correct measurement function and make sure that test leads are connected to respective measuring terminals.
- Do not power the meter from sources other than those listed in this manual.
- **The R<sub>ISO</sub>** inputs of the meter are protected electronically from overload (e.g. due to having been connected to a live circuit) up to 750V rms for 60 seconds.
- Repairs may be performed only by an authorised service point.

## Note:

**Due to continuous development of the meter's software, the actual appearance of the display, in case of some of the functions, may slightly differ from the display presented in this operating manual.**

## 2 Turning the meter ON and activating screen backlight.

①



Turn on the meter with  button.

②



Short press  button to turn the screen backlight on; press the button again to turn the backlight off.

③

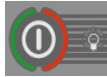

Switch on the meter by pressing and holding  button for approx. 2 sec.

Emergency situations.



Pressing  button for approx. 7 seconds will turn off the meter in case of emergency.

## 3 Meter Configuration

①



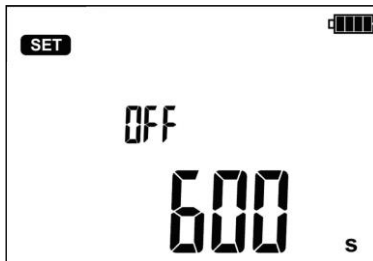

Turn on the meter by pressing and keeping **SETUP** button pressed.



②



Use buttons  and  to set Auto-OFF time or to inactivate this function (horizontal lines – Auto-OFF function is inactive). Auto-OFF function is used to turn-off inactive meter after a preselected time.

③





Use  and  buttons to enter the screen with audio message settings: **bEEP**.

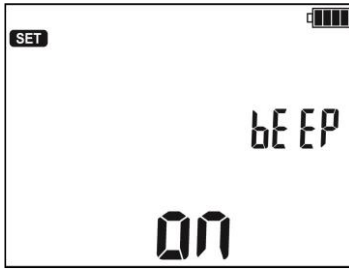



4



Use  and  buttons to turn the audio messages ON (ON) or OFF (OFF).

5



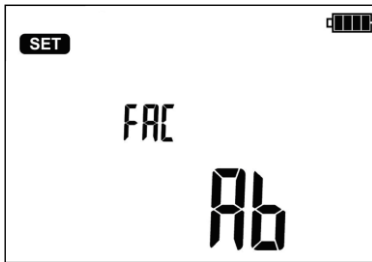

Press  and  buttons to enter the setting the type of absorption coefficients: FAC.



6



Use  and  buttons to set Ab1, Ab2 (Ab) parameters or PI, DAR (P).

7



Use  and  buttons to enter the screen with software update: UPdt.



8



Press **ENTER** to enter the update mode. The update process is described in Chapter 7

After changing the parameters, you may exit **SETUP** menu (not applicable for Update screen):

9



Press **ENTER** to memorize settings

or use **ESC** button to go to the measurement screen without approving the changes.

## 4 Measurements

### 4.1 Measurement of insulation resistance

**WARNING:**  
The tested object must not be live.

**Attention:**  
During measurement, especially of high resistances, make sure that test leads do not touch each other and probes (crocodile clips), because such a contact may cause the flow of surface currents resulting in additional error in measurement results.

#### 4.1.1 Double-lead measurement

1



Use **<<** or **>>** button to start the measurement of  $R_{ISO}$  (LED  is on). The meter is in voltage measurement mode.

2



Press **SET/SEL** button to select the measurement voltage  $U_{ISO}$ , time used for calculating the absorption coefficients **t1**, **t2**, **t3** and the interval between the parameter points **ChA**.

3

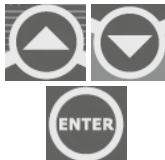

Use **↑** and **↓** buttons to set  $U_{ISO}$  value and confirm it by pressing **ENTER** or





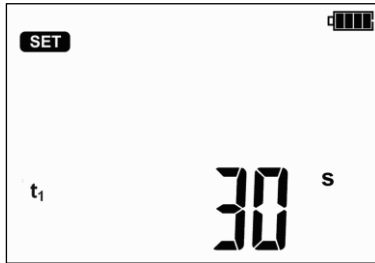

use  button to enter the setting of times for calculating the absorption coefficients.

4

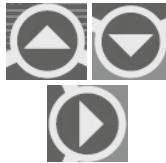

5



Use  and  buttons to set t1 value, use  button to start setting t2 and then t3 value. Press  again to enter the setting of time interval **ChA** of recording **R<sub>iso</sub>**.

Defining ChA interval will enable the user, using Sonel Reader software, to plot the resistance chart and current chart using the data obtained from the performed measurement (see example below).

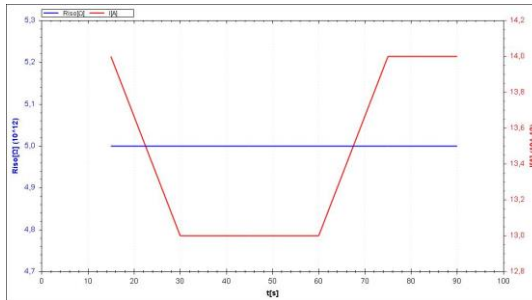



6



7



Use  and  buttons to set the interval (15, 30, 45 or 60 sec.). Horizontal lines indicate unavailability of recording characteristics.

8



or



Press **ENTER** to confirm settings or press **ESC** to exit without saving the changes.

Connect test leads according to the drawing.

9

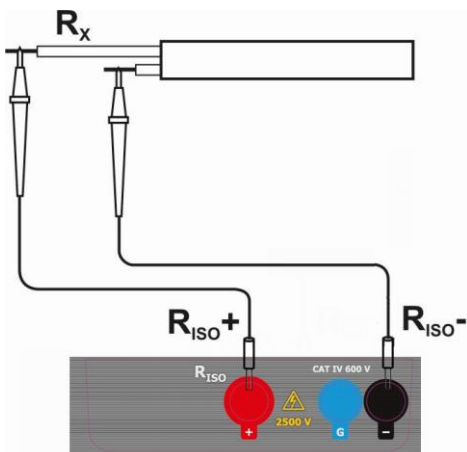

10



The meter is ready for measurement.

11



Press and hold **START** push-button. The measurement is performed continuously until you release the button or the pre-set time is reached.



for 5 sec.

or



+



In order to maintain (hold) the measurement, press and hold **START** button for 5 sec. or press **ENTER** while holding **START** button pressed - symbol  **LOCK** will be displayed indicating automatic measurement, now the buttons may be released. The measurement will end after the longest pre-set time (t1, t2 or t3) runs out. To interrupt or terminate the measurement earlier in the absence

of pre-set t1, t2 or t3 values (measurement without time limit), press again **START** or **ESC** button.

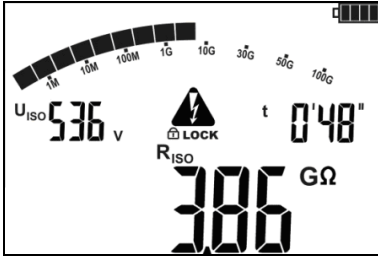

View of the screen during measurement. **LOCK** means that the measurement was started with **ENTER** button or by pressing and holding **START** button for approx. 5 sec.



Use **SET/SEL** to go to display leakage current  $I_L$ .

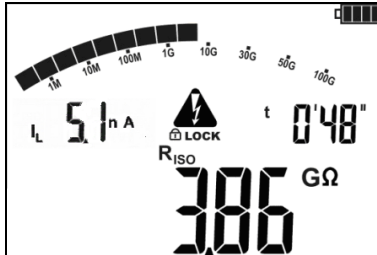

12

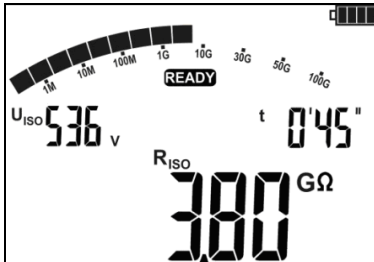

After the measurement is completed or stopped, read the result. The results of all completed measurements will be displayed (even when the measurement was interrupted/stopped e.g. after 60 seconds). When the meter switched into standby mode, the measurement result may be recalled by pressing **ENTER**.

13



Use ◀ and ▶ to see individual components of the result in the following order:

$R_{ISO} \rightarrow L \rightarrow Ab2 \rightarrow Ab1 \rightarrow Rt3 \rightarrow It3 \rightarrow Rt2 \rightarrow It2 \rightarrow Rt1 \rightarrow It1 \rightarrow R_{ISO}$ .

If the measurement is stopped, the displayed values will present the results of partial measurements that have been completed and "---" will represent uncompleted partial measurements.

If the characteristic was measured, then the measurement results may be read between  $It1$  and  $R_{ISO}$ .

## Note:



**During measurements of insulation resistance, dangerous voltage of approx. 2.5kV occurs at the ends of measurement wires of MIC-2501 meter.**



**It is forbidden to disconnect test leads before the measurement is completed. Failure to obey the above instruction will lead to high voltage electric shock and make it impossible to discharge the tested object.**

- Disabling  $t2$  will also disable  $t3$ .
- Timer measuring the measurement time is started when  $U_{ISO}$  voltage is stabilized.
- Symbol **LIMIT** means operation with limited inverter power. If this condition persists for 20 seconds, the measurement is interrupted.
- If the timer reaches characteristic points (tx times or characteristic times), then for 1s instead  $U_{ISO}$  a symbol (mnemonic) of this point is displayed which is accompanied by a long beep.
- If any of the measured values of partial resistance is out of range, the value of the absorption coefficient is not displayed – the display shows dashes.
- During the measurement LED is flashing in yellow.
- When the measurement is complete, capacity of the tested object is discharged by shorting terminals  $R_{ISO+}$  and  $R_{ISO-}$  with resistance of approx. 100 k $\Omega$ . Message „diS“ is displayed. Do not disconnect the test leads before the object capacity is discharged.
- When during viewing the results, voltage is present at terminals  $R_{ISO}$ , LED  $R_{ISO}$  will blink in red and additional two-tone beep will be generated.
- In case of power cables measure the insulation resistance between each conductor and other conductors shorted and grounded (figure below).

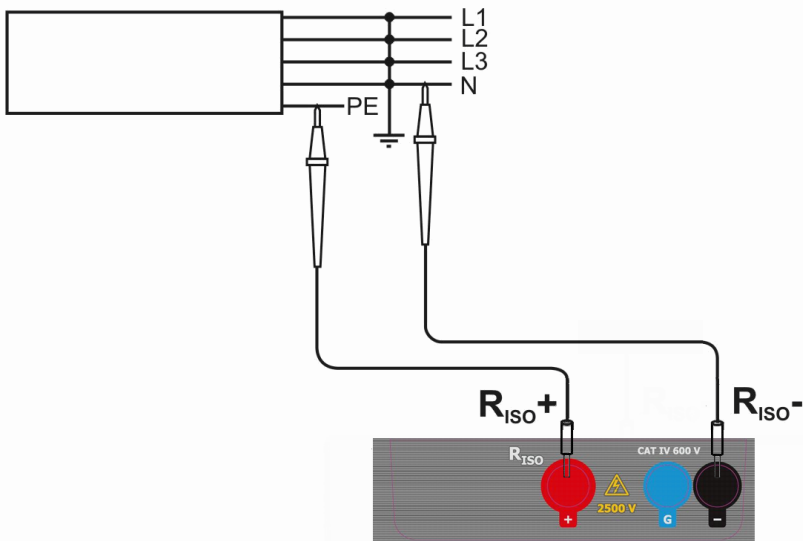

## Additional information displayed by the meter

	Test voltage is present on terminals of the meter.
<b>NOISE!</b>	Interference voltage higher than 25V but lower than 50V, is present on the tested object. Measurement is possible but may be burdened with additional uncertainty.
<b>READY</b> disappears, LED lights red, two-tone beep	Interference voltage higher than 50 V, is present on the tested object. The measurement is blocked.
<b>LIMIT !!</b>	Activation of current limit. The symbol displayed is accompanied by a continuous beep.
<b>H I L E</b>	Breakdown of the tested object insulation, the measurement is interrupted. The message appears after displaying <b>LIMIT !!</b> for 20 s during the measurement, when the voltage previously reached the nominal value.
<b>UdEt</b> , Riso LED is blinking in red and two-tone acoustic signal is generated	During the measurement, AC voltage appeared or the object cannot be discharged for 30 seconds. <b>Immediately</b> disconnect the test leads.

### 4.1.2 Three-lead measurement

In order to eliminate the influence of surface resistance in transformers, cables, etc. the three-lead measurement is used. For example:

- at the measurement of inter-winding resistance of a transformer, **G** socket of the meter should be connected to the transformer tank;

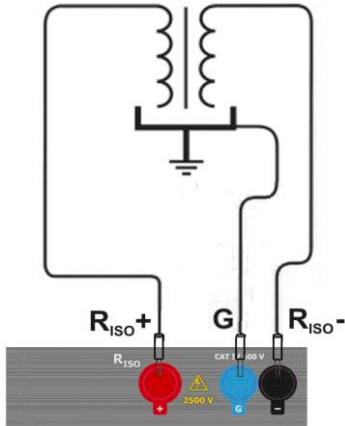

- when measuring insulation resistance between one of the cable conductors and the cable jacket, the effect of surface resistances (important in difficult weather conditions) is eliminated by connecting a piece of metal foil insulating the tested conductor with **G** socket of the meter;

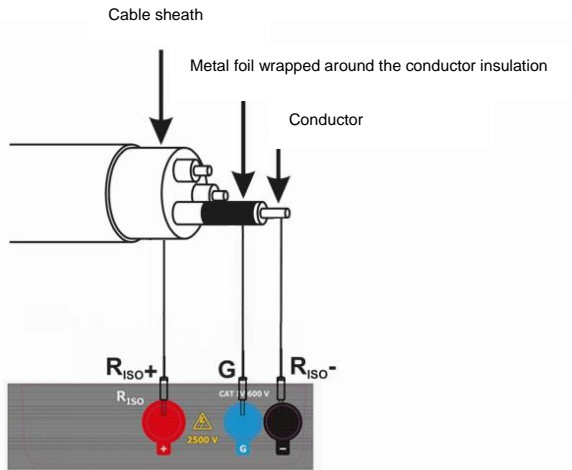

The same shall apply when measuring the resistance between two conductors of the cable, attaching to **G** terminal other conductors that do not take part in the measurement.



## 4.2 Low-voltage measurement of resistance

### 4.2.1 Measurement of resistance of protective conductors and equipotential bonding with 200 mA current

1



Use **<<** or **>>** button to start the measurement of  $R_{\text{CONT}}$  (LED  $R_{\text{CONT}}$  is on). The meter is in the voltage measurement mode.

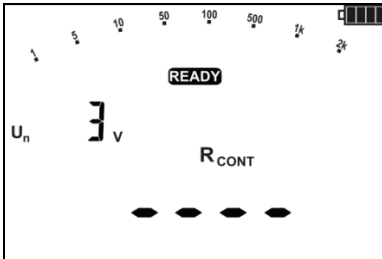

The meter is ready for measurement.

2



Connect the meter to the tested object.  
Trigger the measurement by pressing the **START** button.

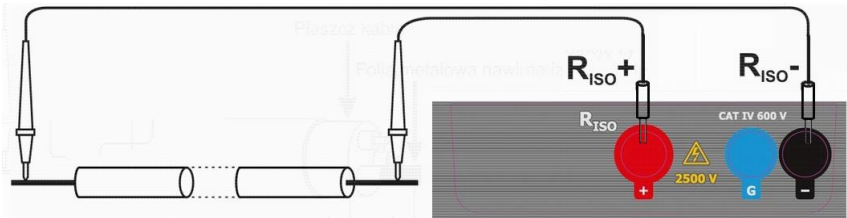

3

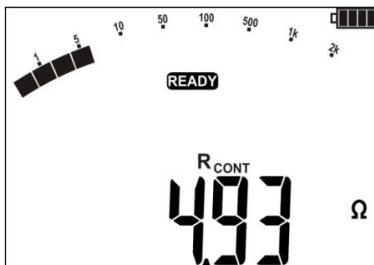

Read out the result.

4



Press **START** push-button in order to start next measurement without disconnecting test leads from the object.

## Additional information displayed by the meter

<b>NOISE!</b>	Interference voltage occurs on the tested object. The measurement is possible however it will be burdened with additional uncertainty that is specified in the technical data.
<b>UdEt</b> , LED $R_{CONT}$ is blinking in red and two-tone acoustic signal is generated	Interference voltage exceeds the allowable value, the measurement is blocked.

### 4.2.2 Compensation of test leads resistance

In order to eliminate the impact of the resistance of test leads on measurement result  $R_{CONT}$ , the compensation (auto-zeroing) of resistance may be performed.

1



In  $R_{CONT}$  mode (LED  $R_{CONT}$  is on) use **SET/SEL** button to enter the screen with Autozeroing the test leads.

2

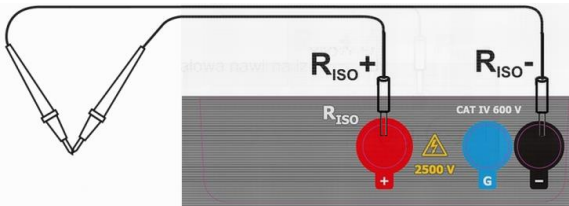

Short the test leads – message **READY** will be displayed.

3



Press **START**.

4

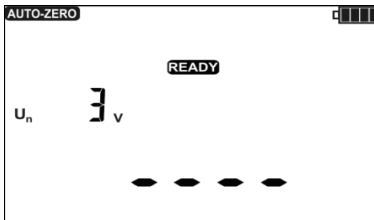

**AUTO-ZERO** message starts to blink, which confirms completion of test leads calibration.

The result is a compensated value and correction is available for  $R_{CONT}$ . The compensation is active even after the meter is switched off and on again.

5

In order to remove the compensation of the leads resistance (return to default calibration), perform the above-mentioned activities with test leads open, instead of test results, the display will show message **OFF** (compensation of test leads is turned off).

6



Return to  $R_{CONT}$  measurement screen by pressing **SET/SEL**

### 4.3 Voltage measurement

1



Use << or >> button to start the measurement of  $U_{\sim}$  (LED  $U_{\sim}$  is on). The meter is in the voltage measurement mode.

2

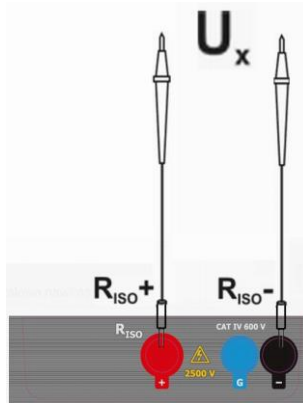

Connect the meter to a voltage source.

3



Measurement is performed in a continuous manner.

### Additional information displayed by the meter

<p><b>&gt;750V</b>, LED is blinking in red, two-tone acoustic signal is generated</p>	<p>Measuring range is exceeded. Voltage is higher than acceptable. <b>Immediately</b> disconnect the test leads.</p>
<p>~ -</p>	<p>When AC voltage is detected, the device will display symbol "~" ("wave") and when DC voltage is detected, the device will display symbol "-" for negative polarity or "nil" for positive polarity.</p>

## 5 Memory of measurement results

MIC-2501 meters have memory divided into 10 banks of 99 cells. Thanks to dynamic memory allocation, each of the memory cells can contain different quantity of single measurement results, depending on the needs. Optimal use of the memory can be ensured in this way. Each measurement result can be stored in a memory cell marked with a selected number and in a selected memory bank. Thanks to this, the user of the meter can, at his/her option, assign memory cell numbers to individual measurement points and the memory bank numbers to individual facilities. The user may also perform measurements in any chosen sequence and repeat them without losing other data.

Memory of measurement results **is not deleted** when the meter is switched off. Thanks to this, the data can be later read or sent to a computer. The number of a current memory cell or memory bank is not changed either.

### Note:

- Results of measurements performed for all measuring functions can be stored in one memory cell, excluding  $U_V$ .
- After entering the measurement result, the ID number of the cell is automatically increased.
- It is recommended to delete the memory after reading the data or before performing a new series of measurements that may be stored into the same memory cells as the previous ones.

### 5.1 Storing the measurement results in the memory

①



After completing measurement press **ENTER**.

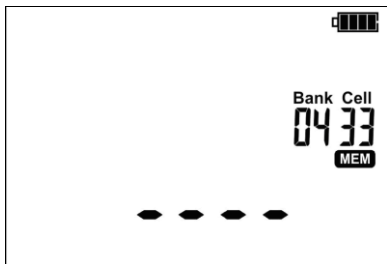

The cell is empty.

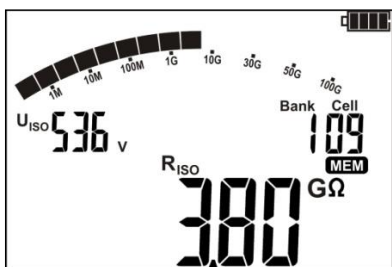

The cell is partially occupied by the same type of result, which is to be entered.

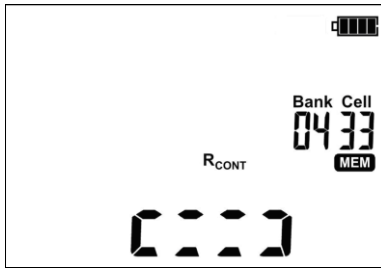

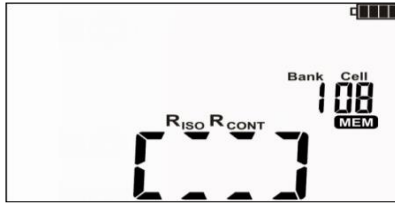

The cell is partially occupied by a different type of result to be entered - symbols of the saved values are displayed.



The cell is fully occupied, symbols (mnemonics) of stored values are displayed.





Use  and  buttons to preview the results stored in the selected cell.

To change the cell number or bank number:

2



When the cell number is flashing, use  and  buttons to set the desired number of the cell.



3



Press **SET/SEL** button – bank number is flashing.

4



Use  and  buttons to set the desired number of the bank.

5



After selecting the desired bank and cell, press **ENTER** button, to save the result in the memory. Recording is indicated by a triple beep. Press **ESC** to return to the measurement screen without saving.

If you try to store data in an occupied memory cell, the following warning message will appear:



6



or



Press **ENTER**, to overwrite the result or **ESC**, to cancel and select other cell or bank.

## Note:

- After the measurement, its result is shown on the display until:

- the measurement function is changed,
- Auto-OFF function is activated,
- the meter detects interference voltage > 50V,
- one of the following operations is performed:
  - **ESC** button is pressed to exit to the voltmeter,
  - next measurement is performed,
  - an entry into the memory is introduced.

- After exiting to the voltmeter by pressing **ESC** or after saving the results to the memory, the last result may be recalled by pressing **ENTER**.

- Complete set of results (main result and supplementary results) for a given measuring function and preset measurement settings are stored in the memory.

## 5.2 Viewing memory data



1



Use << or >> to browse the memory: **MEM**

(LED  is on).





Use  and  buttons to preview the results stored in the selected cell.

To change the cell number or bank number:

2



When the cell number is flashing, use  and  buttons to set the desired number of the cell.

3



Press **SET/SEL** button – bank number is flashing.

4



Use and buttons to set the desired number of the bank.

### Note:

- While viewing  $R_{ISO}$  results, the field of timer / memory displays alternately bank and cell numbers and the time in which the result was entered into memory. This applies to all  $R_{ISO}$  and  $I_L$  measurements.
- Press **ESC** to immediately display basic component of the result.
- For  $R_{CONT}$  there is no option of scrolling through the components of the result.

## 5.3 Deleting memory data

You can delete the entire memory or its individual banks.

### 5.3.1 Deleting bank data

1



Use or to browse the memory:

**MEM** (LED is on).

2

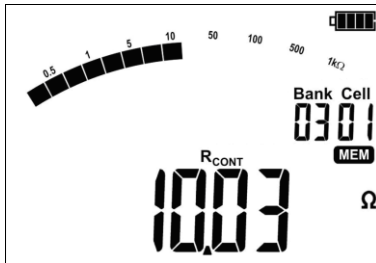

Set the bank number to be deleted acc. to section 4.2.  
Set the **cell number** as "--" (before "01")...



... and the cell number will change into "--", then symbol **del** will be displayed to indicate the readiness for deleting.

3



Press **ENTER** button.

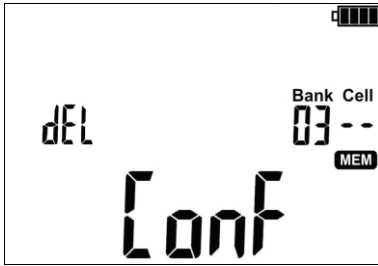

⚠ and **Conf** symbols appear, asking you to confirm deletion.

④



Press **ENTER** button again to delete the selected bank.  
After deleting the bank, the meter beeps three times. Cancel by pressing **ESC**.

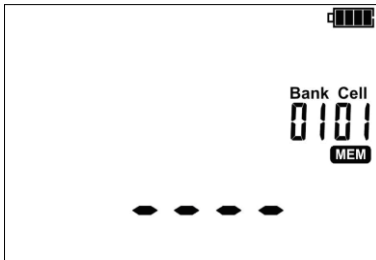

The contents of the bank has been deleted.

### 5.3.2 Deleting the whole memory

①



Use << or >> to browse the memory: **MEM** (LED  is on).

②

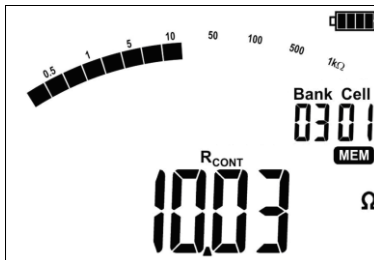

Set the **bank number** as "--" (before "01")...





... the bank number will change into "--", then symbol **del** will be displayed to indicate the readiness for deleting the whole memory.

3



Press **ENTER** button.



⚠ and **Conf** symbols appear, asking you to confirm deletion.

4



or



Press **ENTER** again.

After deleting the memory, the meter beeps three times.

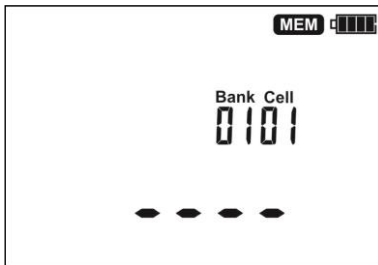

The entire contents of the memory has been deleted.

## 6 Data transmission

### 6.1 Computer connection accessories

In order to operate the meter with a PC, an USB cable and appropriate software are required. If the required software has not been purchased with the meter, it may be downloaded from the manufacturer's website or purchased from the manufacturer or its authorised distributor.

The software may be used for many devices manufactured by SONEL S.A. which are equipped with the USB interface or other (depending on the selected device).

Detailed information is available from the manufacturer and distributors.

### 6.2 Data transmission through USB port

1.



Use << or >> to browse the memory: **MEM** (LED  is on).

2. Connect the cable to the USB port of the computer and the USB socket of the meter. The meter will display the message:



3. Start the program for communicating with the meter (processing results) and follow the commands of the software.

## 7 Software updates

1. In accordance with the guidelines of Section 3 of this manual, enter the meter software update mode: **UPdt**

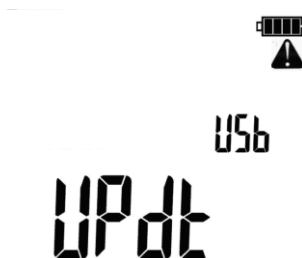

2. Connect the cable to the USB port of the computer and the USB socket of the meter.

3. Start the program for updating the meter and follow the commands of the software.

## 8 Power supply

### 8.1 Monitoring the power supply voltage

The charge level of the battery pack is indicated by the symbol in the right upper corner of the display on a current basis:

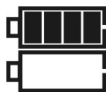

The battery pack is charged.

The charge of battery pack is low. Only voltage measurement is available.

No battery icon (when the charger is connected). The battery pack is disconnected or damaged.



The battery pack is fully discharged, all measurements are blocked.

The meter switches off automatically after 5 sec.

### 8.2 Charging the battery pack

#### CAUTION!

**MIC-2501 meter is powered from SONEl battery pack, which includes NiMH 9.6 V batteries and it may be replaced only by the manufacturer's service department.**

Battery charger is installed inside the meter and cooperates only with the manufacturer's rechargeable battery pack. The charger is powered by external power supply adapter. The device may be also powered from the car cigarette lighter socket (**12V only**), using an optional charger.

Charging commences once the power supply has been connected to the meter regardless of the fact whether the meter is on or off (only the charging mode is different - as described below). When the meter is switched off - the charging process is indicated on the screen by displaying animated symbol of battery being charged; when the meter is switched off - the charging is indicated by blinking LED's of measurement functions (they blink consecutively in red).

Charging modes:

- the meter (user interface) is switched off: the battery pack is charged in "quick charging" mode - the charging process takes approx. 4 hours. Completed charging is indicated by full battery symbol, **FULL** message and beep. In order to fully turn the device off, unplug the power charger.

- the meter (user interface) is switched on: the battery pack is charged in "background charging" mode - the charging may be longer than the charging process of the device which is switched off. Completed charging is indicated by full battery symbol and beep. If the charging time exceeds 10 hours, the meter will automatically switch off for safety reasons.

In order to fully turn the device off, unplug the power charger and turn the meter off.

#### CAUTION!

**Do not power the meter from sources other than those listed in this manual.**

## Note:

- Due to interferences in the mains, the process of battery pack charging may finish prematurely. When charging time is too short, turn off the meter and start charging again.

## Additional information displayed by the meter

Signalling	Cause	Solution
Displayed message: <b>Err ACU Hi°C</b>	Temperature of the battery pack is too high!	Wait until the battery pack is cool. Start charging process again.
Displayed message: <b>Err ACU Lo°C</b>	Temperature of the battery pack is too low.	Wait until the battery pack is warm enough. Start charging process again.
Displayed message: <b>Err ACU X</b> (where X is the number of error)	Emergency	Try to start the charging process again. When powering the device from the cigarette lighter socket, check whether the socket supplies 12V voltage. If this does not help, the battery pack may be damaged - contact the manufacturer's service.
<b>No battery icon</b> (when the charger is connected)	The battery pack is disconnected or damaged.	Contact the manufacturer's service.

### 8.3 General principles regarding using Ni-MH rechargeable batteries

- Store the rechargeable batteries (the meter) in a dry, cool and well ventilated place and protect them from direct sunlight. The temperature of the environment in the case of prolonged storage should not exceed 30°C. If the rechargeable batteries are stored for a long time in a high temperature, then the occurring chemical processes may reduce their lifetime.

- Rechargeable batteries NiMH usually lasts for 500-1000 charging cycles. The rechargeable batteries reach their maximum capacity after being formatted (2-3 charge and discharge cycles). The most important factor which influences the lifetime of rechargeable batteries is the level of their discharge. The deeper the discharge level of the batteries, the shorter their lifetime.

- The memory effect is limited in the case of NiMH batteries. These batteries may be charged at any point with no serious consequences. However, it is recommended to discharge them completely every few cycles.

- During storage of Ni-MH rechargeable batteries they are discharged at the rate of approximately 20% per month. Keeping rechargeable batteries at high temperatures may accelerate this process even 100%. In order to prevent excessive discharge of rechargeable batteries, after which it would be necessary to format them, it is recommended to charge them from time to time (even if they are not used).

- Modern fast chargers detect both too low and too high a temperature of the battery pack and react to the situation adequately. Too low temperature should prevent starting the process of charging, which might irreparably damage rechargeable batteries. An increase of the temperature of the rechargeable batteries is a signal to stop charging and is a typical phenomenon. However charging at a high ambient temperature apart from reducing batteries' lifetime causes an accelerated increase of their temperature and the result is that the batteries are not charged to their full capacity.

- Please note that when the batteries are charged with a fast-charger they are charged only to approx. 80% of their capacity - better results can be achieved by continuing charging; the charger enters trickle-charging mode and during the next few hours batteries are charged to their full capacity.

- Do not charge or use the batteries in extreme temperatures. Extreme temperatures reduce the lifetime of batteries and rechargeable batteries. Avoid placing devices powered by rechargeable batteries in very hot environments. The nominal working temperature must be absolutely observed.

## 9 Cleaning and maintenance

### **CAUTION!**

**Use only the maintenance methods specified by the manufacturer in this manual.**

The casing of the meter may be cleaned with a soft, damp cloth using all-purpose detergents. Do not use any solvents or cleaning agents which might scratch the casing (powders, pastes, etc.).

Clean the probe with water and dry it. Before the probe is stored for a prolonged period of time it is recommended to grease it with any machine lubricant.

The reels and test leads should be cleaned with water and detergents, and then dried.

The electronic system of the meter does not require maintenance.

## 10 Storage

In the case of storage of the device, the following recommendations must be observed:

- Disconnect all the test leads from the meter.
- Clean the meter and all its accessories thoroughly.
- Wind the long test leads onto the reels.
- In order to prevent a total discharge of the battery pack in the case of a prolonged storage, charge it from time to time.

## 11 Dismantling and Disposal

Worn-out electric and electronic equipment should be gathered selectively, i.e. it must not be placed with waste of another kind.

Worn-out electronic equipment should be sent to a collection point in accordance with the law of waste electrical and electronic equipment.

Before the equipment is sent to a collection point, do not dismantle any elements.

Observe local regulations concerning disposal of packages, waste batteries and accumulators.

## 12 Technical specifications

### 12.1 Basic data

⇒ Abbreviation "m.v." used in the specification of basic uncertainty means standard measured value

#### AC / DC voltage measurement

Display range	Resolution	Basic uncertainty
0...299.9 V	0.1 V	±(3% m.v. + 2 digits)
300...750 V	1 V	

- Frequency range for AC: 45 Hz...65 Hz

#### Measurement of insulation resistance

Measuring range according to IEC 61557-2:  $R_{ISOmin} = U_{ISOnom}/I_{ISOnom} \dots 1000 \text{ G}\Omega$  ( $I_{ISOnom} = 1 \text{ mA}$ )

Double-lead measurement

Display range	Resolution	Basic uncertainty
0.0 k $\Omega$ ...999.9 k $\Omega$	0.1 k $\Omega$	± (3 % m.v. + 20 digits)
1.000 M $\Omega$ ...9.999 M $\Omega$	0.001 M $\Omega$	
10.00 M $\Omega$ ...99.99 M $\Omega$	0.01 M $\Omega$	
100.0 M $\Omega$ ...999.9 M $\Omega$	0.1 M $\Omega$	
1.000 G $\Omega$ ...9.999 G $\Omega$	0.001 G $\Omega$	
10.00 G $\Omega$ ...99.99 G $\Omega$	0.01 G $\Omega$	
100.0 G $\Omega$ ...999.9 G $\Omega$	0.1 G $\Omega$	
1000 G $\Omega$	1 G $\Omega$	

- When the range is exceeded, the device displays ">xxxxG $\Omega$ " (where xxxx is the limit value for the selected range).

Approximate maximum values of the measured resistance, depending on the test voltage, are presented in the table below. For other voltages the range limits may be read from the chart below.

Voltage	Test range
up to 100 V	50 G $\Omega$
200 V...400 V	100 G $\Omega$
500 V...900 V	250 G $\Omega$
1000 V...2400 V	500 G $\Omega$
2500 V	1000 G $\Omega$

⇒ **Note:** For insulation resistance below  $R_{ISOmin}$  there is no accuracy specified because the meter works with the adjustable current limit in accordance with the following formula:

$$R_{ISOmin} = \frac{U_{ISOnom}}{I_{ISOnom}}$$

where:

- $R_{ISOmin}$  – minimum insulation resistance measured without limiting the converter current
- $U_{ISOnom}$  – nominal test voltage
- $I_{ISOnom}$  – nominal inverter current (1 mA)

- Max. short-circuit current:  $I_{SC} = 1.4 \text{ mA} \pm 15 \%$

## Measurement of leakage current

Display range	Resolution	Basic uncertainty
0...ILmax	m, $\mu$ , n	Calculated basing on resistance measurements

- ILmax – maximum current at short circuit of leads,
- resolution and units result from the measurement range of individual insulation resistance.

## Low-voltage measurement of continuity of circuit and resistance

### Measurement of continuity of protective conductors and equipotential bondings with $\pm 200$ mA current

Measuring range according to IEC 61557-4: 0.10  $\Omega$ ...999  $\Omega$

Display range	Resolution	Basic uncertainty
0.00 $\Omega$ ...19.99 $\Omega$	0.01 $\Omega$	$\pm(2\%$ m.v. + 3 digits)
20.0 $\Omega$ ...199.9 $\Omega$	0.1 $\Omega$	
200 $\Omega$ ...999 $\Omega$	1 $\Omega$	$\pm(4\%$ m.v. + 3 digits)

- Voltage at open terminals: 4 V...24 V
- Output current at  $R < 2 \Omega$ :  $I_{SC} > 200$  mA
- Compensation of test leads resistance
- Measurements for both current polarizations.
- When the range is exceeded, the device displays "> 999  $\Omega$ " message

### Other technical data

- type of insulation ..... double, acc. to EN 61010-1 and IEC 61557
- measurement category ..... IV 600 V (III 1000 V) acc. to EN 61010-1
- degree of housing protection acc. to EN 60529..... IP65
- power supply of the meter..... SONEL battery pack, NiMH 9.6 V 2 Ah
- Battery charging time ..... usually 4 h, max. 10 h
- parameters of the external power supply adapter ..... 90 V...264 V, 50 Hz...60 Hz
- dimensions ..... 200 mm x 150 mm x 75 mm
- meter weight..... approx. 1.0 kg
- allowable batter pack charging temperatures in mode 500mA ..... +10  $^{\circ}$ C...+40  $^{\circ}$ C
- temperatures at which the charging process is interrupted ..... <0  $^{\circ}$ C and  $\geq$  +50  $^{\circ}$ C
- operating temperature range with external power supply adapter ..... <0  $^{\circ}$ C and  $\geq$  +50  $^{\circ}$ C
- storage temperature ..... -20  $^{\circ}$ C...+60  $^{\circ}$ C
- operating temperature ..... -15  $^{\circ}$ C...+40  $^{\circ}$ C
- humidity ..... 20 %...80 %
- reference temperature ..... +23  $^{\circ}$ C  $\pm$  2  $^{\circ}$ C
- reference humidity ..... 40 %...60 %
- altitude (above sea level) ..... <2000 m
- number of measurements  $R_{ISO}$  acc. to PN-EN 61557-2..... approx. 800
- modular ..... LCD
- memory of measurement results ..... 990 cells
- data transmission ..... USB connection
- quality standard... design, construction and manufacturing are ISO 9001, ISO 14001, PN-N-18001 compliant
- the device meets the requirements of IEC 61557 standard
- the product meets EMC requirements (immunity for industrial environment) according to the following standards..... EN 61326-1:2013 and EN 61326-2-2:2013

## 12.2 Additional data

Data on additional uncertainties are useful mainly when the meter is used in non-standard conditions and for metrological laboratories for the purpose of calibration.

### 12.2.1 Additional uncertainties according to IEC 61557-2 ( $R_{ISO}$ )

Significant parameter	Designation	Additional uncertainty
Position	E <sub>1</sub>	0 %
Supply voltage	E <sub>2</sub>	0% ( <b>BAT</b> is not lit)
Temperature 0 °C...35 °C	E <sub>3</sub>	0.1 %/°C

### 12.2.2 Additional uncertainties according to IEC 61557-4 ( $R \pm 200$ mA)

Significant parameter	Designation	Additional uncertainty
Position	E <sub>1</sub>	0 %
Supply voltage	E <sub>2</sub>	0.5% ( <b>BAT</b> is not lit)
Temperature 0 °C...35 °C	E <sub>3</sub>	1.5%

## 13 Accessories

### 13.1 Standard equipment

The standard set of equipment supplied by the manufacturer includes:

- MIC-2501 meter – **WMPLMIC2501**
- shielded wire 1.8 m, 5 kV, ended with banana plugs, black (cat. IV 1 kV) - **WAPRZ1X8BLBB**
- shielded wire 1.8 m, 5 kV, ended with banana plugs, red (cat. IV 1 kV) – **WAPRZ1X8REBB**
- shielded wire 1.8 m, 5 kV, ended with banana plugs, blue (cat. IV 1 kV) – **WAPRZ1X8BUBB**
- crocodile clip, 5,5 kV, black (cat. IV 1 kV) – **WAKROBL32K09**
- crocodile clip, 5,5 kV, red (cat. IV 1 kV) – **WAKRORE32K09**
- crocodile clip, 5,5 kV, blue (cat. IV 1 kV) – **WAKROBU32K09**
- probe 5 kV, red (cat. IV 1 kV), – **WASONREOGB2**
- probe 5 kV, black (cat. IV 1 kV) – **WASONBLOGB2**
- external adapter for battery pack charging – **WAZASZ7**
- USB cable – **WAPRZUSB**
- case – **WAFUTM8**
- calibration certificate
- operating manual
- guarantee card.

### 13.2 Optional accessories

Additionally, the following items that are not included in the scope of standard equipment can be purchased from the manufacturer or the distributors:

#### **WAPRZ005BLBBE5K**

- 5 m shielded cable, black, cat. IV 1000 V

#### **WAPRZ005REBB5K**

- 5kV cable, 5m, red, with banana plugs

#### **WAPRZ005BUBB5K**

#### **WAPRZ010BLBBE5K**

- 10 m shielded cable, black, cat. IV 1000 V

#### **WAPRZ010REBB5K**

- 5kV cable, 10 m, red, with banana plugs

#### **WAPRZ010BUBB5K**



- 5kV cable, 5m, blue, terminated with banana plugs

#### WASONPRS1PL



- probe insulation resistance of floors and walls PRS-1

#### WAPROSONPE5



- "SONEL Pomiary Elektryczne" (SONEL Electrical Measurements) - software for generating measurement reports

- 5kV cable, 10m, blue terminated with banana plugs

#### WAPRZLAD12SAM



- cable for charging the battery pack from the car cigarette lighter socket (12V)

#### WAADACS1



- cable simulator CS-1

#### LSWPLMIC2501

- calibration certificate

#### Note

The software is supported by the following systems: Windows XP (Service Pack 2) or later.

## 14 Manufacturer

The manufacturer of the device and provider of guarantee and post-guarantee service:

**SONEL S.A.**  
 ul. Wokulskiego 11  
 58-100 Świdnica  
 Poland  
 tel. +48 74 858 38 60  
 fax +64 74 858 38 09  
 E-mail: [export@sonel.pl](mailto:export@sonel.pl)  
 Web page: [www.sonel.pl](http://www.sonel.pl)

#### Note:

Service repairs must be performed only by the manufacturer.

## 15 Laboratory services

Research and Calibration Laboratory of SONEL SA offers calibration of the following instruments used for electrical/non-electrical measurements:

- meters for electrical protective measurements: insulation resistance, impedance and resistance of short-circuit loops, earthing resistances and earth resistivity, RCD parameters and multi-functional meters that perform the above functions,
- electrical safety meters,
- multimeters,
- power quality analysers,
- meters for measuring low resistance values,
- infra-red cameras,
- pyrometers,
- luxmeters.

In addition, the Laboratory performs voltage, current and resistance calibration.

A calibration certificate is a document confirming compliance of parameters declared by the manufacturer of tested device with national standards, specifying the measurement uncertainty.

Pursuant to standard **EN ISO 10012:2003** "Measurement management systems — Requirements for measurement processes and measuring equipment", SONEL S.A. recommends for its instruments to be periodically tested, observing the interval of **13 months**.

For new devices with calibration certificates, the next metrological inspection (calibration) is recommended within **13 months** from the date of purchase, but not later than **19 months** from the date of manufacture.

**Note:**

**In case of instruments used for tests related to the protection against electric shock, the person - performing measurements should have complete confidence in the efficiency of operated apparatus. Measurements carried out with malfunctioning meter may cause wrong assessment of tested equipment in terms of its protection features**





**SONEL S.A.**  
Wokulskiego 11, St  
58-100 Swidnica  
Poland



**+48 74 85 83 860**  
**+48 74 85 83 800**  
**fax +48 74 85 83 809**

**<http://www.sonel.pl>**  
**e-mail: [export@sonel.pl](mailto:export@sonel.pl)**