



Cable routes without secrets thanks to LKZ-1000

Features

- Backlit LCD with contrast (auto on-off).
- Automatic adjustment of detection sensitivity.
- 5 operating modes.
- Warning about shallowly located cables.
- Measuring cable locations up to 3 m deep.
- Determining the direction of a cable.
- Sound signals to facilitate locating or tracing.
- Adjustment of power and selection of frequencies for the transmitter.
- Passive or active modes of tracing.
- Detection of underground live wires.
- Detection of underground wires with no voltage (radio mode).
- Detection of underground wires with no voltage using a transmitter (galvanized, inductive or clamp-based connection).
- Tracing metallic or non-conductive pipes using an additional probe.
- Tracing non-conductive pipelines using a "floating" probe.
- Tracing a determined cable.
- Determining the depth of a cable.



Characteristics

Improved LKN-1000 transmitter delivers significantly higher power than previous model, which allows to:

- Tracking underground services over a, longer distances,
- Improve service detection in areas of high signal interference,
- Improve depth estimation.

Other benefits of the new transmitter:

- four adjustable output levels with maximum output level, of 1 W,
- durable waterproof design environmental protection rating of IP65,
- smaller and lighter designed to work in harsh conditions,
- choice of 3 tracing signals, 8 kHz or 33 kHz, in conductive mode 8 kHz and 33 kHz at the same time,
- clear visual and visual signals for easier operation,
- built-in test function – allowing operators to test the hardware and software functionality of the LKN-1000 before use,
- externally located control buttons, ensure a waterproof.



Operating modes

- Passive, with 50 Hz or 60 Hz – enables to locate live wires and cables (POWER).

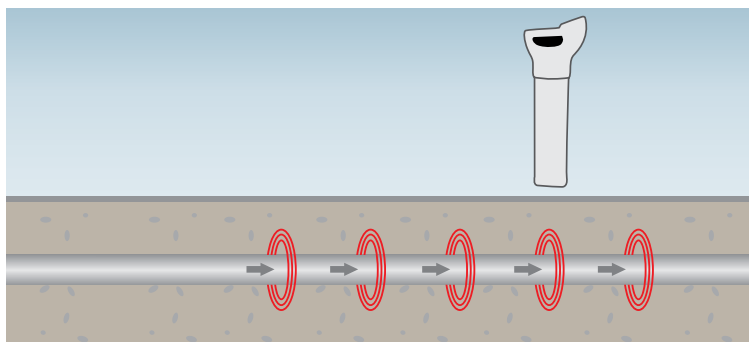

- Passive RADIO (15-30 kHz) – enables a quick, non-selective locating operation for an underground structure (metallic installations).

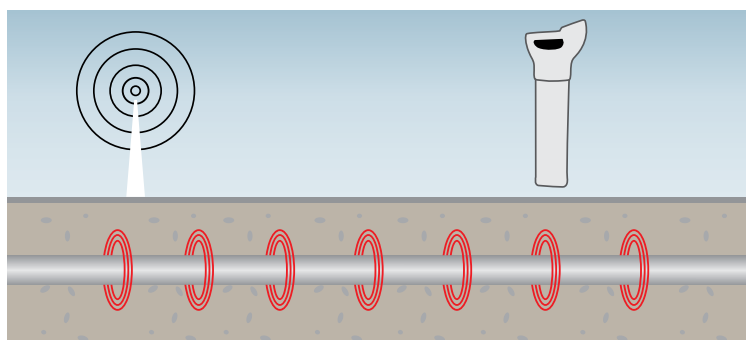

- Active (with transmitter) (8 kHz and 33 kHz), enables:

- » a locating operation using the inductive mode (all one has to do is to place the transmitter over the object traced),
- » a locating operation through connecting the transmitter directly to an object that is not live,
- » a locating operation using transmission clamps (it is necessary to close the clamps over the object tested),
- » a locating operation using a transmission wire or transmission probes (enables to locate non-metallic objects),
- » a locating operation using a separating adapter (connecting the transmitter LKN-1000 directly to a 230 V socket).

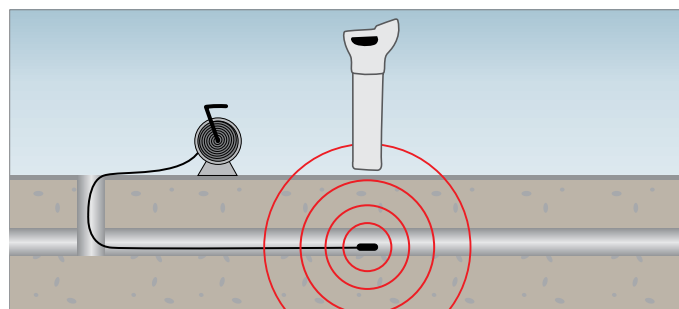
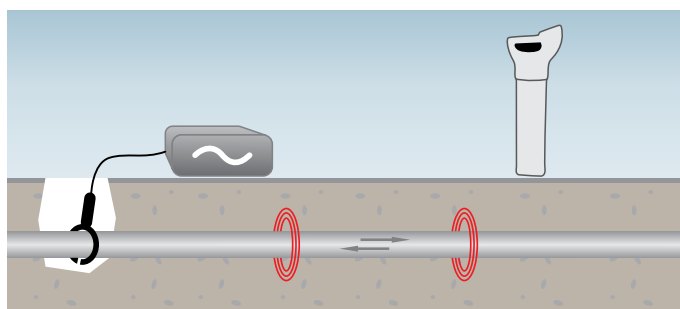
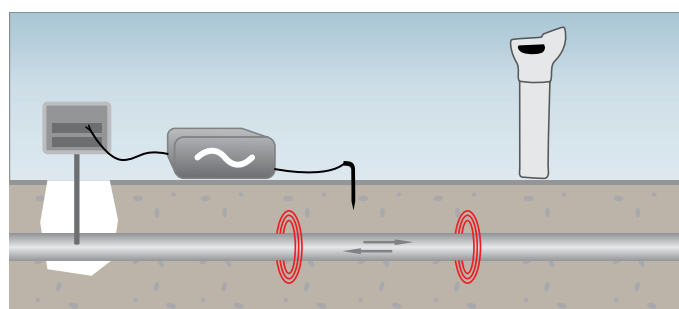
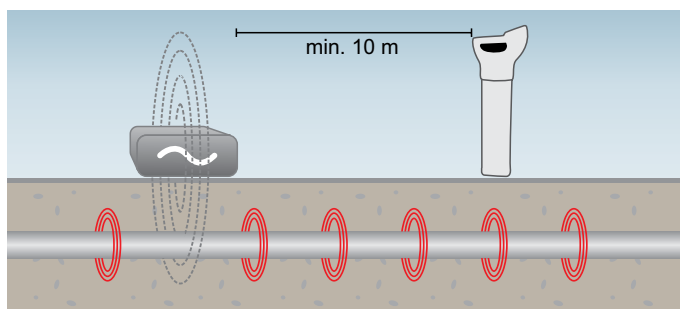

Technical specifications

LKN-1000 transmitter

Ingress protection	IP65
Power supply	4x LR20 battery
Dimensions	180 x 280 x 260 mm
Weight	ca. 2.4 kg
Operating temperature	-20...+55°C
Storage temperature	-40...+70°C
Humidity	95%

LKO-1000 receiver

Ingress protection	IP54
Power supply	6x LR6 battery
Dimensions	760 x 250 x 85 mm
Weight	ca. 2.7 kg
Operating temperature	-20...+50°C
Storage temperature	-40...+70°C
Humidity	95%

Standard accessories



LKN-1000 cable locator - transmitter

WMGBLKN1000



LKO-1000 cable locator - receiver

WMGBLKO1000



Bag L6

WAFUTL6



Ground probe 15 cm

WASONG15

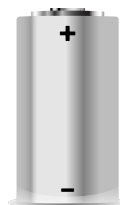

**4x LR20 battery
6x LR6 battery**

Optional accessories



**Transmitting clamp
N-2 (Ø100 mm)**

WACEGN2XLR



**AS-1 separating
adapter**

WAADAAS1PL



**NAD-1 transmission
probe**

WASONNAD1



**Wire to locate non-
metallic installations**

30 m
WAPRZPN30

50 m
WAPRZPN50

80 m
WAPRZPN80