



## USER MANUAL

**THERMAL IMAGER**  
**KT-560 • KT-650 • KT-670**





# **USER MANUAL**

## **THERMAL IMAGERS KT-560 • KT-650 • KT-670**

**SONEL S.A.  
Wokulskiego 11  
58-100 Świdnica  
Poland**

Version 2.04 04.10.2022



**KT-560, KT-650 and KT-670** Thermal Imagers comply with current EU directives related to electromagnetic compatibility and safety.

All products of Sonel S.A. are manufactured in accordance with Quality Management System which is approved to ISO9001:2008 for the design, manufacturing and servicing.

Due the continuous development of our products, we reserve the right to introduce changes and improvements in the thermal imaging camera and in the software described in this manual without prior notice.

### **Copyrights**

© Sonel S.A. 2022. All rights reserved. This manual may not be copied, reproduced, translated or transferred to any electronic carriers or in machine-readable form, in whole or in part, without the prior written consent of Sonel S.A.

# CONTENTS

<b>1</b>	<b>Introduction</b>	<b>6</b>
<b>2</b>	<b>Safety</b>	<b>7</b>
<b>3</b>	<b>Description of the camera</b>	<b>9</b>
3.1	The camera body	9
3.2	Turning the camera on/off and the standby mode	10
3.3	Arrangement of information on the screen	11
3.4	Gallery	12
3.5	Shortcut menu	14
3.6	Pull-up menu	15
3.7	Laser rangefinder	15
<b>4</b>	<b>Observation</b>	<b>16</b>
4.1	Displaying image on screen/viewfinder	16
4.2	Image modes	16
4.3	Temperature measurement	18
4.4	Focus adjustment	18
4.5	Digital zoom	19
4.6	Manual calibration	19
<b>5</b>	<b>Capturing and saving images</b>	<b>20</b>
5.1	Taking images	20
5.2	Panorama stitching	21
5.3	Super-resolution	21
5.4	Timed shooting	22
<b>6</b>	<b>Recording and storing infrared videos</b>	<b>23</b>
6.1	Video recording	23
6.2	Timed video recording	23
<b>7</b>	<b>Image analysis</b>	<b>24</b>
7.1	Real-time analysis	24
7.1.1	Adding/deleting analysis objects	24
7.1.2	Changing the size of the analysis object	25
7.1.3	Linear analysis object	25
7.1.4	Palette switching	25
7.1.5	Graphic stroke	26
7.1.6	Difference temperature analysis	26
7.1.7	LEVEL/SPAN switch	27
7.1.8	File browsing	27
7.2	Thermal image analysis	28
7.2.1	Image editing	28
7.2.2	Image zoom	29
7.2.3	Creating a PDF	29
7.2.4	Video playback	30
7.3	Isotherms	31
7.4	Custom emissivity	32
<b>8</b>	<b>Settings</b>	<b>33</b>
8.1	Search	33

8.2	Temperature alarm	33
8.3	Image marks	34
8.4	Image watermark	34
8.5	Key assist	34
8.6	Unit switch	34
8.7	Save parameters	35
8.8	Laser ranging	35
8.9	Report parameters	35
8.10	Preference settings	35
8.11	Password lock	35
8.12	Shutdown and sleep	35
8.13	Cloud service	35
8.14	Wi-Fi	35
8.15	Network connections	36
8.16	Bluetooth	37
8.17	General	37
8.18	Storage	38
8.19	License information	38
8.20	Date and time	38
8.21	Language	38
8.22	Synchronous data	38
8.23	Format SD card	38
8.24	Recovery	38
<b>9</b>	<b>Accurate temperature measurement</b>	<b>39</b>
<b>10</b>	<b>Port connection</b>	<b>40</b>
10.1	Micro HDMI port	40
10.2	USB port	40
10.3	LAN port	41
<b>11</b>	<b>SD card</b>	<b>42</b>
11.1	Installing SD card in the camera	42
11.2	Removing SD card	43
<b>12</b>	<b>Replacing the lens</b>	<b>44</b>
<b>13</b>	<b>Power supply and battery charging</b>	<b>45</b>
13.1	Using AC adapter	45
13.2	Battery power supply	45
13.3	Charging batteries	45
13.4	Charging the battery in the external battery charger	46
13.5	General rules of using Lithium (Li-Ion) batteries	47
<b>14</b>	<b>Troubleshooting</b>	<b>48</b>
<b>15</b>	<b>Specifications</b>	<b>49</b>
<b>16</b>	<b>Cleaning and maintenance</b>	<b>50</b>
<b>17</b>	<b>Service and storage</b>	<b>50</b>
<b>18</b>	<b>Dismantling and disposal</b>	<b>51</b>

**19 Accessories.....51**  
    19.1 *Standard accessories* ..... 51  
    19.2 *Optional accessories*..... 52  
**20 Manufacturer .....53**  
**21 Exemplary emissivity coefficient values .....54**  
**22 Laboratory services.....55**

# 1 Introduction

Thank you for purchasing our thermal imager.

KT series imagers are modern, high-quality, easy and safe to use measuring devices. The infrared detector allows to capture high-quality, fully radiometric thermal images. Our products combine high-quality measurement parameters with an innovative and intuitive interface to create an intelligent solution in the field of thermal imaging.

The camera operation, with a large, movable, touch screen is very comfortable. Together with the pivoting part of the camera body, where the high grade lens is located, these set of features create an ideal solution that brings the camera's ease of use to a new level, especially in places that require difficult angle shots. Thanks to the built-in viewfinder, bright outdoor lighting is not an issue. In addition to standard modes like IR (infrared), visual and PIP (picture in picture), the camera has a mode for mixing images, overlapping and blending outlines of the visual image on the infrared image. User can take and store static images or record and save video clips. The available range of software tools allows an image analysis on the go, also in the live mode.

Each infrared image can have a text note, voice annotation and/or sketch attached to it. With the provision of built-in GPS and compass, the camera automatically tags the locations where the pictures are being taken. On site reports are possible with the embedded PDF report editor. The camera provides a number of ways to connect with external devices, both wired and wirelessly.

Please acquaint yourself with this manual to improve your daily work with the device, and to avoid measuring errors and prevent possible problems related to operation of the imager.



Camera operation and available options may vary depending on the version of the camera. This manual describes the operation based on the highest available camera configuration.



## 2 Safety

Before you proceed to operate the camera, acquaint yourself thoroughly with the present manual and observe the safety regulations and specifications defined by the manufacturer.

- Any application that differs from those specified in the present manual may result in a damage to the device and constitute a source of danger for the user.
- The camera must not be used in rooms where special conditions are present e.g. fire and explosion risk.
- It is forbidden to use damaged or malfunctioning camera and is partially or fully out of order.
- In case the camera is not used for a long time, its battery should be removed.
- It is not allowed to use the camera with half-closed or opened battery cover and do not use any other power adapter than the one supplied with the camera.
- Repairs may be carried out only by an authorised service point.

KT series Thermal Imagers are designed to measure and record the images in the infrared. The camera is constructed in a manner which gives you maximum performance and safety at work, however the following precautions must be adhered to at all times (in addition to any advised precautions applicable at the relevant work site or work area):

- Keep the camera steady during operation.
- Do not use the camera in ambient temperatures exceeding its operation and storage temperature ranges.
- **Do not direct the camera toward very high intensity radiation sources such as the sun, lasers or welding arcs etc.**
- Do not expose the camera to dust and moisture. When operating the device near water, ensure that it is adequately guarded against splashes.
- When the camera is not in use or is to be transported, ensure that the unit and its accessories are stored in the protective carry case.
- Do not obstruct the speaker holes in the camera's body.
- Do not re-switch on the imager before 30 seconds after switching it off and do not remove the battery when the imager is on.
- Do not throw, knock or shake intensely the camera and its components in order to avoid the damage.
- Do not attempt to open the imager's body, as this action will void the warranty.
- Keep the SD memory card for the exclusive use of the camera.
- During operation, if the camera is to be moved from hot/cold place to cold/hot place, e.g. from inside/outside to outside/inside of a room, switch the imager off and leave it in the new workplace for 20 minutes, then turn it on and start normal operation with an accurate temperature measurement. Sudden and rapid changes in ambient temperature may cause fault temperature measurement and even damage camera's IR detector.
- FPA calibration (FPA – Focal Plane Array): in order to ensure accurate temperature measurement, the FPA detector was calibrated in different temperature points. After switching the imager on, it performs auto calibration procedure every once in a while. During the calibration, for about 1 second, **the device does not respond to user's activity**, during this time the sound of a shutter clicking twice is heard. Additionally, calibration can be performed manually at any time.
- During imager operation its housing temperature increases and it's a normal phenomenon.



### WARNING

- **Laser locator installed in the camera may be dangerous to eyes, in case of direct contact!**
- **DO NOT DIRECTED THE LASER BEAM TOWARDS OTHER PERSONS OR ANIMALS!**
- **Please note that the laser beam may reflect off shiny surfaces.**
- **AFTER TURNING THE CAMERA ON, IT PERFORMS INTERNAL TEST, DURING WHICH, FOR FEW SECONDS, LASER POINTER IS BEING TURNED ON AS WELL. AFTER TURNING THE CAMERA ON, UNTIL IT REACHES THE POINT OF BEING FULLY OPERATIONAL IT IS FORBIDDEN TO AIM IT AT HUMAN AND ANIMALS!!**



### NOTE!

- The thermal imager has no parts that could be repaired or modified by its user. Never attempt to dismantle or modify the device. Opening up the unit invalidates the warranty.
- Use only accessories listed in this manual. Using other accessories does not ensure proper operation of the camera and may cause its damage.



Due to the continuous development of the device, the design of the display and its certain features may be slightly different than presented in this manual.

## 3 Description of the camera

### 3.1 The camera body

External parts of the camera body:

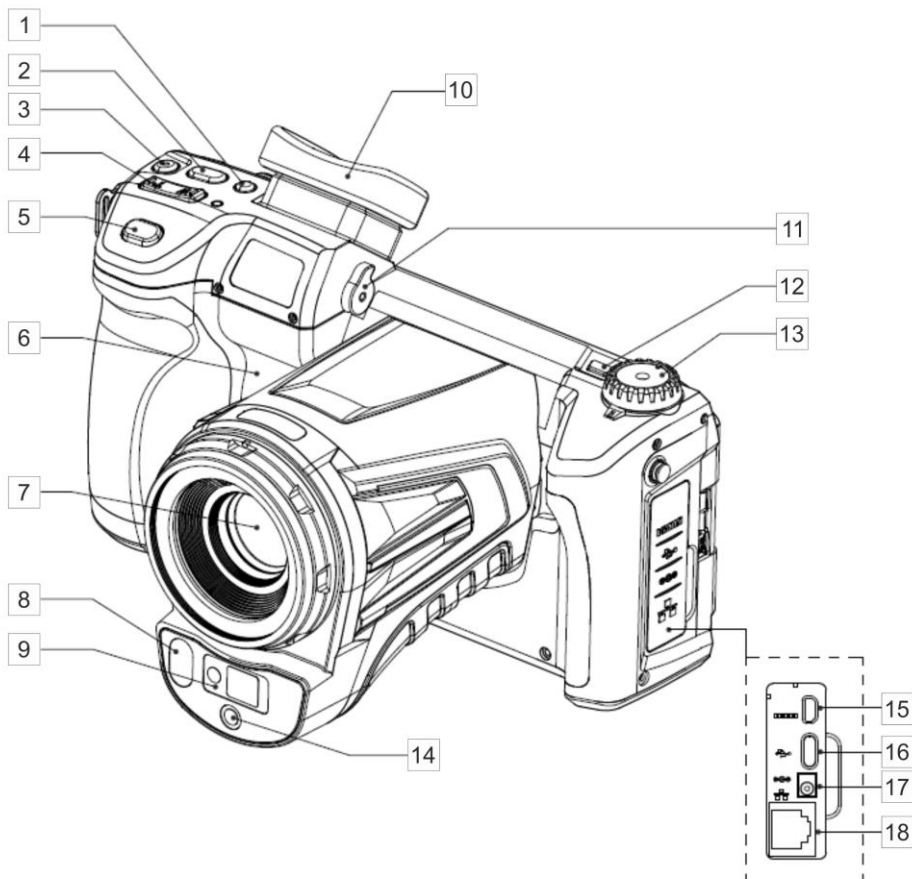

1	Display/View Finder switch button	10	Viewfinder
2	„C” button (programmable)	11	Viewfinder focus adjustment
3	Laser ranging button	12	Power On/Off button
4	Focus adjustment buttons (T – zoom in, W – zoom out)	13	Image mode rotary selector
5	Trigger button (freeze / save image)	14	Visual image lens
6	Speaker	15	Micro HDMI connector
7	IR lens	16	Type-C microUSB connector
8	LED flashlight	17	Power supply connector
9	Laser pointer	18	LAN connector (RJ45)

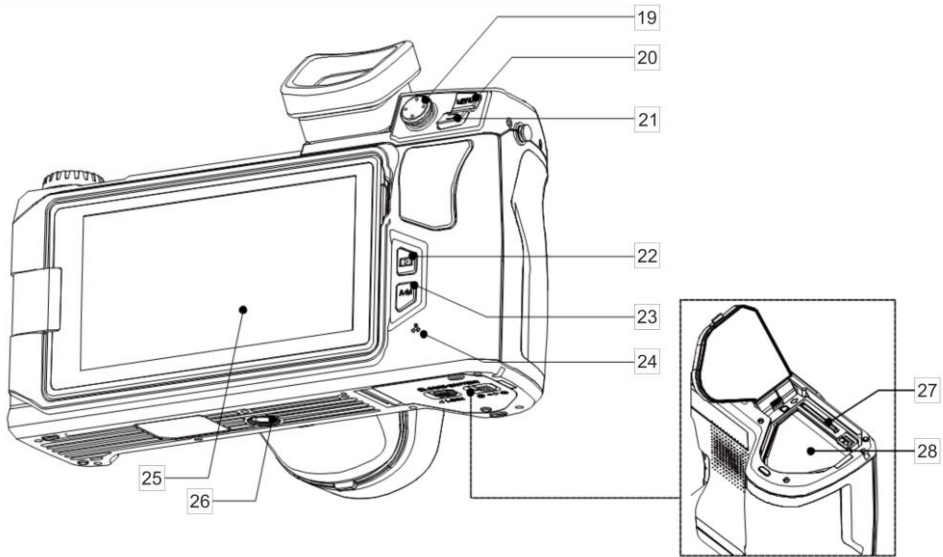

19	Joystick	24	Microphone
20	MENU button	25	Display
21	Return button	26	Tripod socket
22	Gallery (view stored photos/videos )	27	SD card slot
23	Auto/Manual temperature range selection button	28	Battery compartment

Further on in this document, every reference to '[number in brackets]', refers to the camera description presented in the table and drawings above.

### 3.2 Turning the camera on/off and the standby mode

To switch on the camera, press and hold **on/off** button [12] for around 2 seconds. A splash screen will be displayed, followed by the self-test procedure of the device. When the procedure is completed, the camera is ready to be used, and real time infrared image mode is on.

Short pressing the **on / off** button at working camera will turn off the screen and the camera will switch into a power saving mode (standby mode). A second press of **on / off** button will resume the camera to its normal operation.

To switch off the camera completely, press and hold down **on/off** button, until following information appears on the screen: (POWER OFF?). The camera will then be switched off.

Press **OK** to turn off the camera or **Cancel** to cancel the switch off procedure.

### 3.3 Arrangement of information on the screen

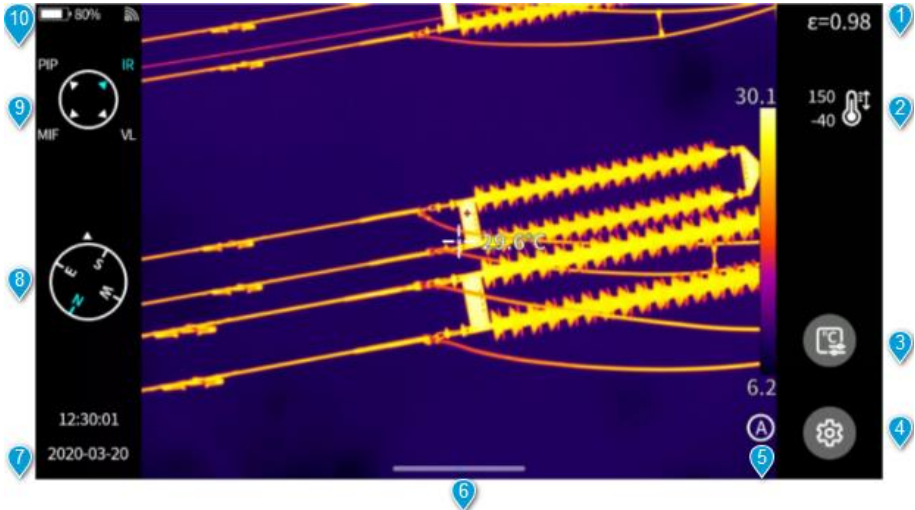

- 1 **Emissivity.** Set the emissivity value of the measured object.
- 2 **Temperature measurement range.** Click to enter the interface of temperature measurement range settings.
- 3 **Temperature measurement parameters.** Click to enter the interface of temperature measurement parameters settings (relative humidity, distance and atmospheric transmissivity, etc.).
- 4 **General settings.** Alternatively, you can enter by pressing the physical button **MENU**.
- 5 **LEVEL SPAN mode.** The default is automatic mode. You can switch among automatic, semi-automatic and manual modes through the physical button or touch screen.
- 6 **Popup-menu icon.** Entering the popup shortcut interface, you can set up the shortcut menu.
- 7 **Time and date.** To change it, go to **Setting ► General ► Date and time**.
- 8 **Compass information.** To enable/disable it, go to **Setting ► Image tag**.
- 9 **Active image mode.**
- 10 **Status bar.**

### 3.4 Gallery

1

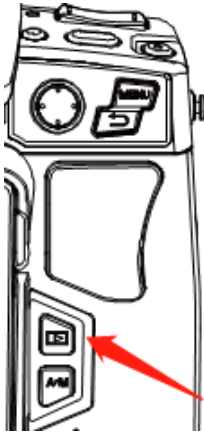

Press the **Gallery** button on the device body.

2

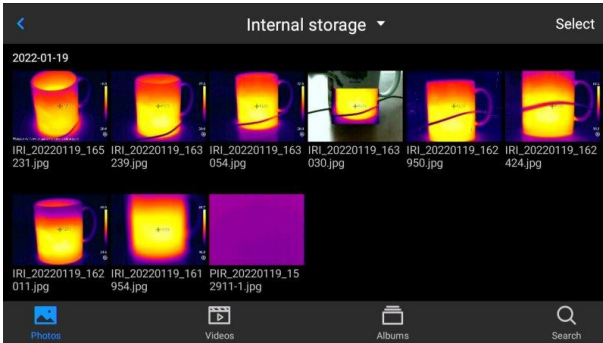

You may directly enter the file browser.

3

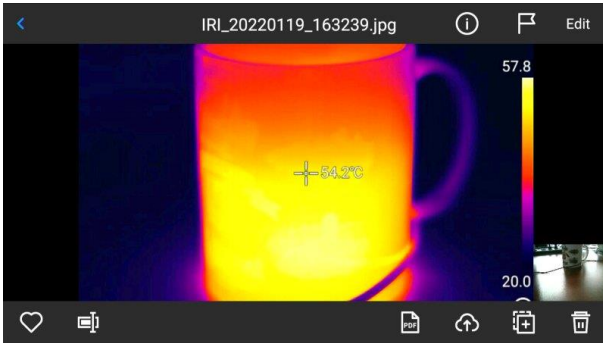

Touch and select the image to view and edit it.

In the Image Preview:

- click any image to enter the Image Edit interface,
- click any area outside the menu to preview the current infrared image in full screen.

Click  to mark the current image.

Click  to modify the image name. There are three ways of naming on this device:

- text recognition naming,
- keyboard input naming,
- voice naming.

Click  to view information of the image.

Click  to add annotations to the image, mainly including:

- visual photo,
- voice,
- OCR text note,
- text note.

Click the **Edit** button to analyze the image, add and modify objects, isotherms and the temperature difference between two points.

Click **PDF** button to generate a PDF preview file.

Click  to upload the current image to the cloud server. See **sec. 8.13** for details.

Click  to move the image to other storage locations.

Click  to delete the image.

Click on the **visible light picture** in the lower right corner to preview the visible light picture corresponding to the current infrared image on the large screen.

### 3.5 Shortcut menu

You can enter the shortcut menu by pressing . This interface is used mainly for some shortcut operations in Real-time Images, including: image analysis, temperature measurement analysis, parameter modification, graphic stroke, isotherm, temperature difference and other shortcut operations.

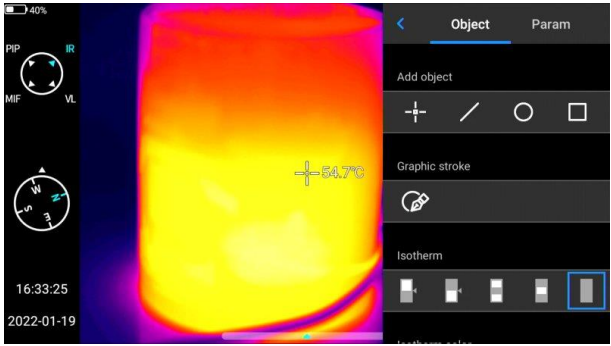

Press the **Back** button on the device or click  to exit the shortcut menu and return to the real-time interface.

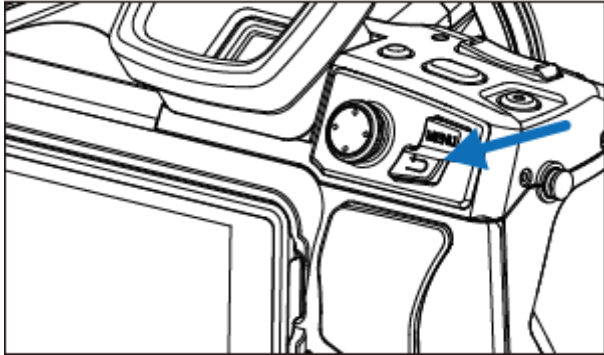



### 3.6 Pull-up menu



In the real-time image mode, click or slide up the icon at the bottom of the screen to pop up a shortcut menu. You may view the storage capacity of local memory or SD card and perform some quick operations, including brightness, volume, Bluetooth, Wi-Fi, laser, panoramic stitching, and super-resolution settings.

### 3.7 Laser rangefinder

Laser rangefinder can be activated, while being in real time mode, by pressing button [3].



#### **WARNING**

**The laser beam may damage your eyes in case of contact, therefore DO NOT DIRECT YOUR EYES TOWARD THE LASER BEAM, and do not direct the laser beam toward people and animals! Pay particular attention, as the laser beam can reflect off the shiny surfaces.**

## 4 Observation

### 4.1 *Displaying image on screen/viewfinder*

During the camera operation in real time mode, the image can be displayed on either the LCD screen or in the viewfinder. Toggle between these two display modes with button [1].

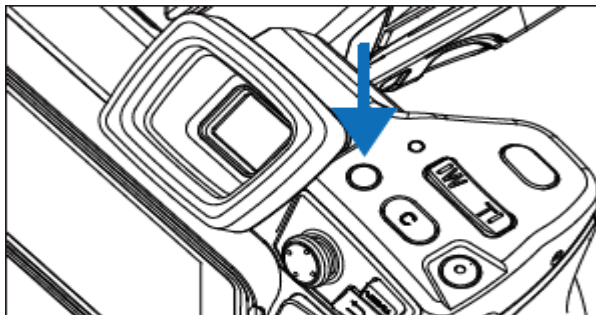

### 4.2 *Image modes*

The camera captures both thermal and the visual images. Use the rotary selector to set the displayed image mode.

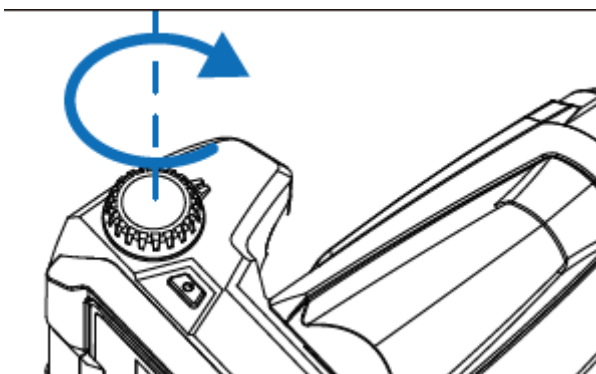

There are four modes available.

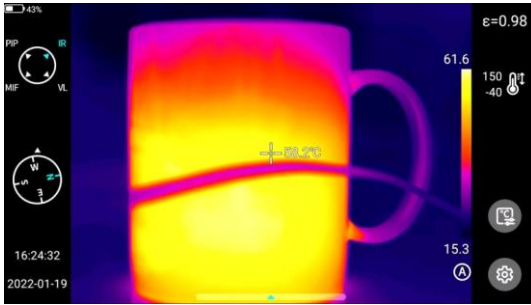

**IR** – infrared image.



**VL** – visual image.

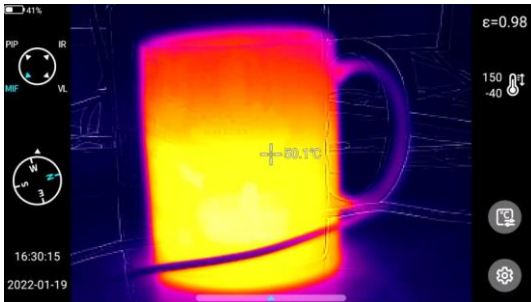

**MIF** – infrared image combined with visual image.

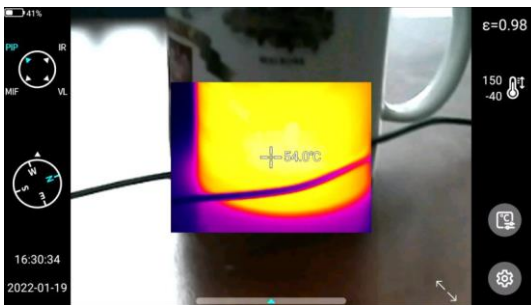

**PIP** – picture in picture – both infrared and visual images are displayed.

### 4.3 Temperature measurement

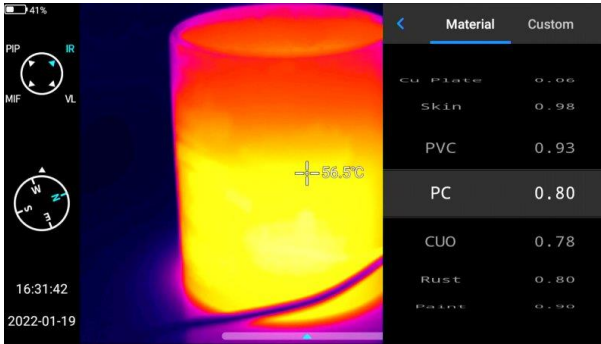

In the Real-time Image state, select the emissivity of the measured object by clicking the **Emissivity bar**. Press **Back** button or click any area on the screen other than the menu to return to the real-time interface. Then aim the center cursor at the measured object for temperature measurement.

### 4.4 Focus adjustment

You can push the joystick up and down to adjust the far focus/near focus.

Alternatively, customize the function button **C** as auto focus (**Set ► Button assist ► Auto focus**), aim at the object to be measured, press **C** and wait until focusing is finished.

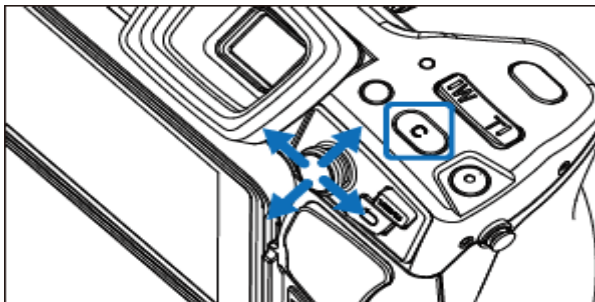

## 4.5 Digital zoom

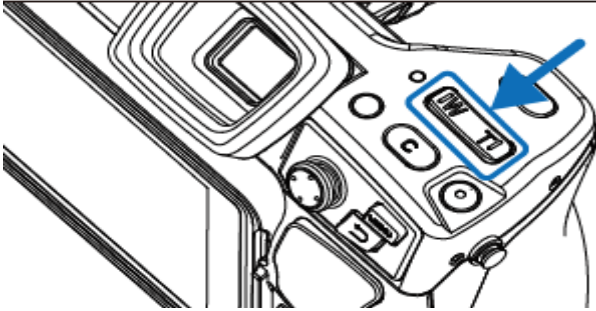

Press the buttons **W** (zoom in) and **T** (zoom out) to perform digital zoom operation.

## 4.6 Manual calibration

- During operation the camera performs auto calibration procedure every once in a while. During the calibration, for about 1 second, **the device does not respond to user's activity**, during this time the sound of a shutter clicking twice is heard.  
Calibration can be performed manually at any time. In order to do that, the 'C'(2) button needs to be programmed into 'Calibration' mode (the 'C' button programming process is described in **section 8.5**). Then, while in infrared real time mode press 'C'(2) button and the calibration procedure will be carried out.

## 5 Capturing and saving images



- Thermal image is saved in "extended jpeg format". Thanks to that it can be viewed in all image browsers and graphics software (stored preview image will be viewed in those cases). In addition, all the information related to the thermogram is stored in one single extended jpeg file as well: temperature of each and every pixel of thermal image, voice annotation and image marks.
- Editing thermal image in software other than Sonel ThermoAnalyze software will result in losing all of the thermographic data.
- If there is not enough space to save a file on SD card or when a saving error occurs, proper information will be displayed on screen.
- Saved thermal image file name is **IRIxxxx.jpg** (where xxxxx are digits). Additionally a separate file with a visual image is saved (as **VISxxxx.jpg**, where xxxxx is the same number as in its corresponding thermal image file name). Both files must be placed in the same folder if the visual image is to be used for an analysis in Sonel ThermoAnalyze program.

### 5.1 Taking images

1

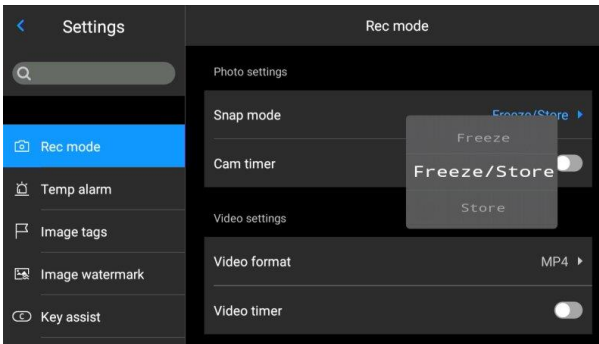

In the Real-time Image state, press the trigger button [5] to freeze the current scene, take images and save. Go to **Settings** ► **Shoot mode** and directly set the function of trigger button as image taking, thus achieving one-button taking pictures.

2

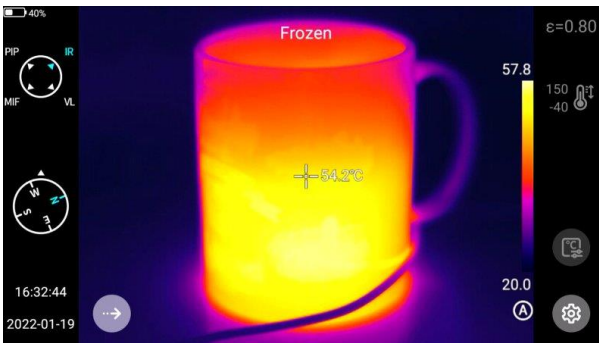

Press the trigger button. The image gets frozen as shown in the figure.

3

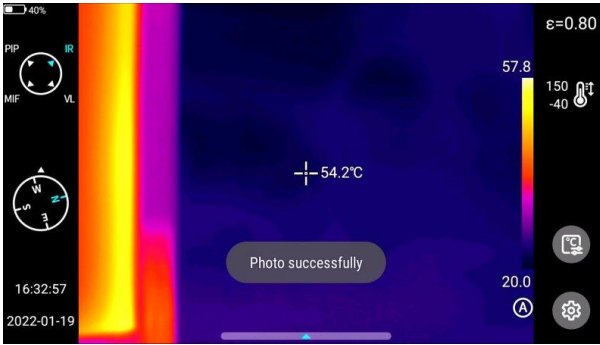

In the frozen state, press the trigger button again to save the image.

## 5.2 Panorama stitching



Users may enable the **panoramic stitching** function. In this function two or more images from the device are stitched into one panoramic. This function needs to be supported by ThermoAnalyze 3 software – **Image Stitching**.

## 5.3 Super-resolution

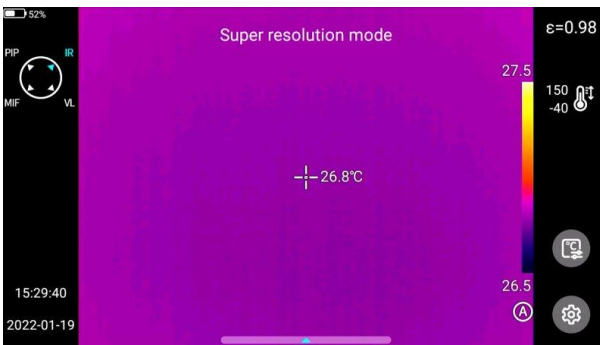

Users may enable taking pictures in super-resolution shooting. This function enlarges the original image 4 times to get a high-resolution image, which supports re-editing.

## 5.4 Timed shooting

1

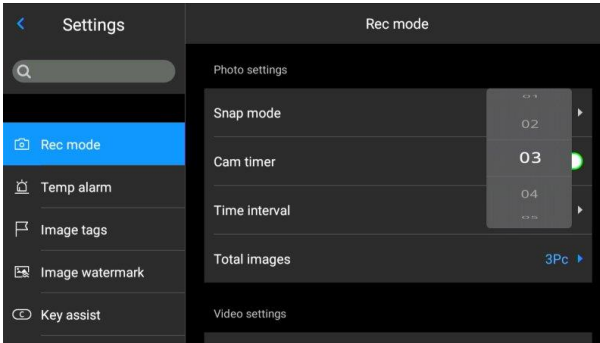

In live mode go to **Settings** ► **Shoot Mode** ► **Image Shoot Mode** and enable the timed shooting function.

2

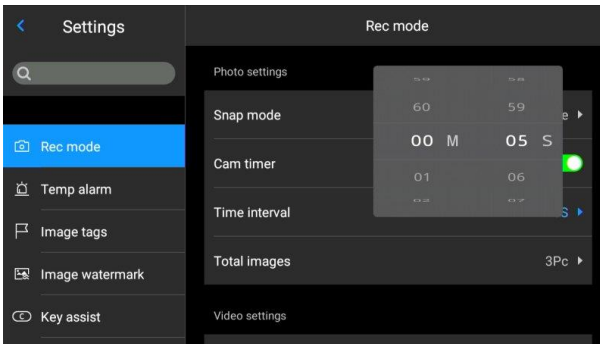

In order to set the number of automatic shootings:

- click the **Image Number** option and select the number of images,
- click the **Time Interval** option to select the appropriate time interval,
- return to the live mode, press the trigger button. The set number of images will be taken with the set interval.



## 6 Recording and storing infrared videos

### 6.1 Video recording



Long press the trigger button to start recording. Press the button briefly to stop recording and save the file.

### 6.2 Timed video recording

①

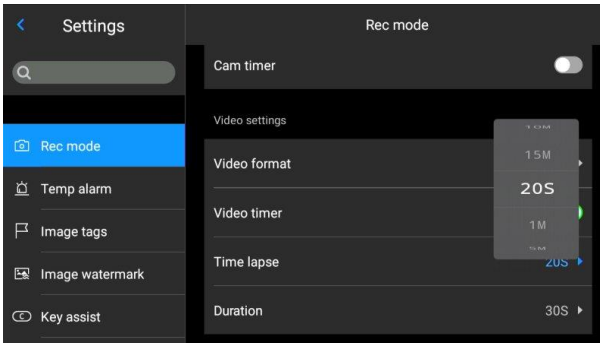

Go to **Settings** ► **Timed video recording**.

②

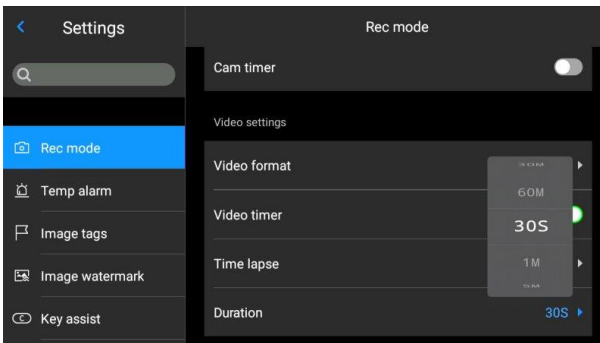



- Click the **delay time** item and select the delay time.
- Click the **duration** item, and select the recording duration.
- Return to the live mode. Long press and hold the trigger button to start the timed recording.

# 7 Image analysis

## 7.1 Real-time analysis

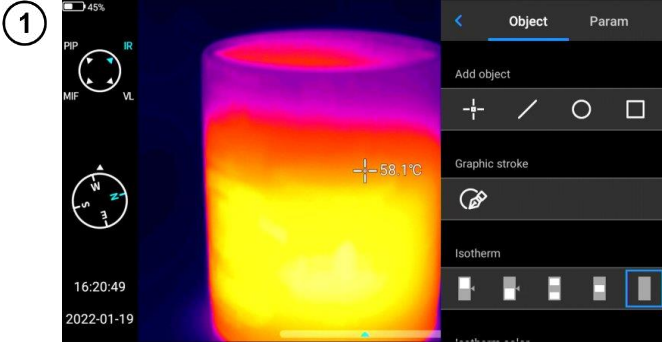
### 7.1.1 Adding/deleting analysis objects



Click the shortcut menu  on the right of the real-time interface to enter the menu interface of adding analysis objects.

- Various analysis objects are available.
- You can also customize the display of the highest temperature, lowest temperature, average temperature value and center display function.



Press and hold any analysis object. An object menu will pop up. The following functions are available:

- **displayed temperature marks** – highest temperature, lowest temperature and average temperature,
- **emissivity** – control the emissivity in the area,
- **center** – controls whether the analysis object is displayed in the center,
- **delete button** – you may delete the current analysis object by touching the  button.

## 7.1.2 Changing the size of the analysis object

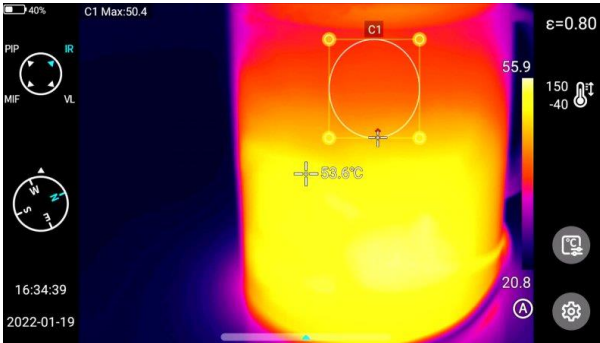

- Select an analysis object. All of its nodes are selected.
- Move any node to change the area of the analysis object.

## 7.1.3 Linear analysis object

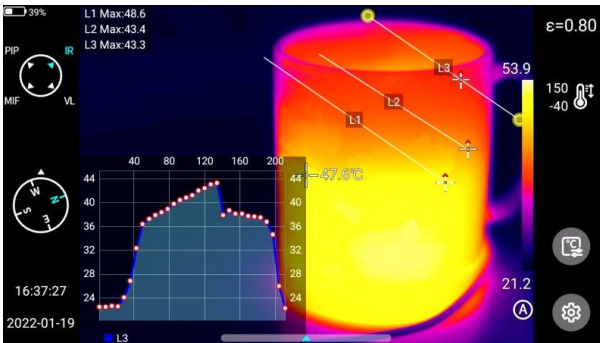

Up to 3 linear analysis objects can be added and displayed simultaneously in live mode.

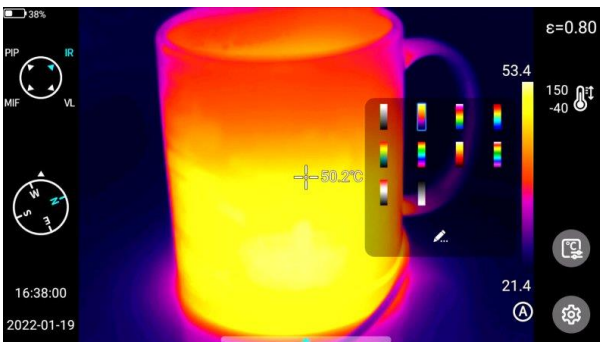

## 7.1.4 Palette switching

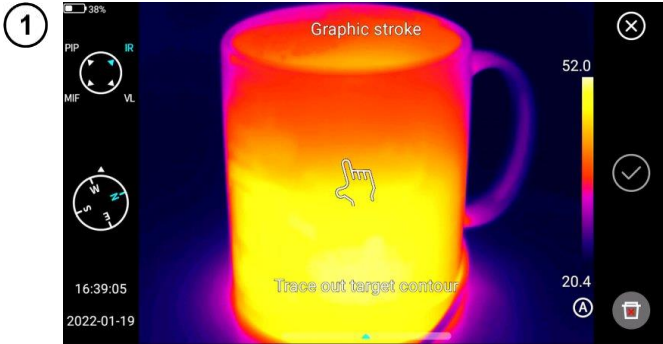

- Enter the main interface.
- Click the palette area on the right side of the screen. Palette options appear.
- Select the color palette.

## 7.1.5 Graphic stroke



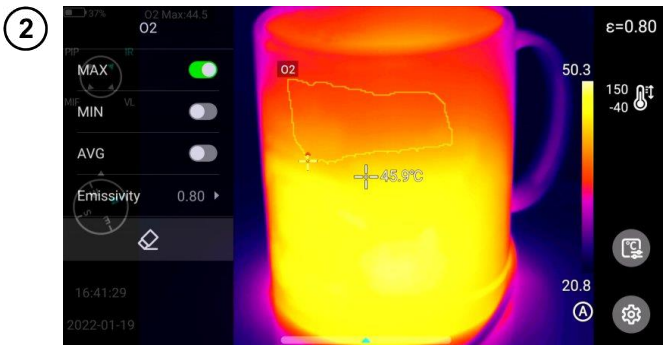

- Click the shortcut menu  on the right of the real-time interface to manually draw the outline of the interested target.
- Click  to generate the outline and analyze the selected target.

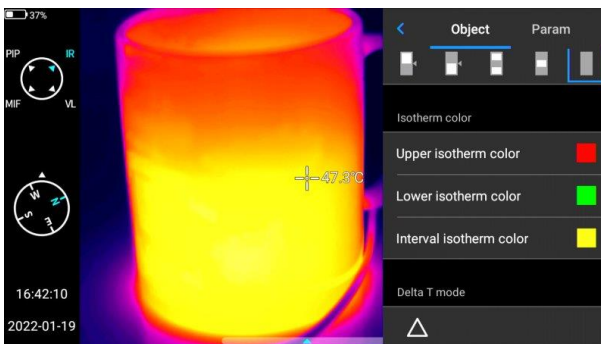

- Long press the stroked object. The object menu will appear.
- In the menu you can analyze the added strokes, delete them and set their emissivity.

## 7.1.6 Difference temperature analysis



- Add at least two analysis objects.
- Click the temperature difference button  under the object label to activate the temperature difference mode.
- In order to exit the temperature difference analysis, enter the shortcut menu-temperature difference and click the  icon.

## 7.1.7 LEVEL/SPAN switch

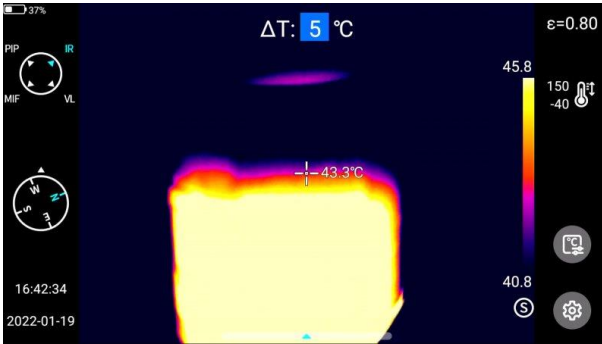

- In the IR live mode, open the Menu.
- Press the **A/M button** [23]. The highest and lowest temperature of the color band in the real-time video image will be locked.
- Click the highest temperature or lowest temperature, and the system will automatically display the corresponding numerical value.
- After selecting the appropriate high or low temperature value, click any screen area to save the temperature value and return to live mode.

In the IR live mode, press **A/M button** to enter the manual dimming mode. The dimming parameters are unlocked.

### LEVEL adjustment

The LEVEL can be adjusted by the “Up” and “Down” key of the joystick [19].

- The “Up” key is to increase  $T_{max}$  and  $T_{min}$  values at the same time.
- The “Down” key is to decrease  $T_{max}$  and  $T_{min}$  values at the same time.

During the adjustment process, the image dimming changes synchronously.

### SPAN adjustment

The SPAN can be adjusted by the “Left” and “Right” key of the joystick.

- When the “Right” key is pressed, the  $T_{max}$  value decreases while  $T_{min}$  increases.
- When the “Left” key is pressed, the  $T_{max}$  value increases while  $T_{min}$  value decreases.

During adjustment, image dimming changes synchronously.

In the IR live mode, press **A/M button** to enter the semi-automatic dimming mode. The  $\Delta T$  value box will pop up at the top of the interface. By using the “Up” key or “Down” key, adjust the value between  $T_{min}$  and  $T_{max}$ , where  $\Delta T = (T_{max} - T_{min})/2$ .

## 7.1.8 File browsing

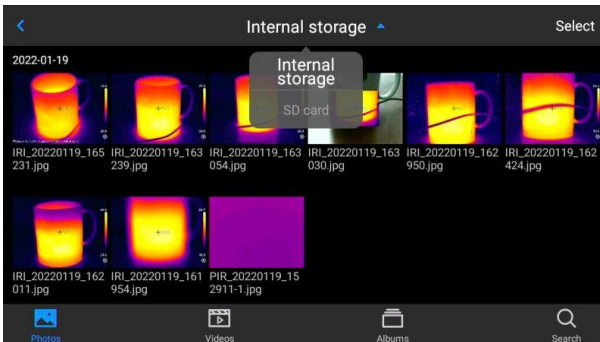

### Internal memory files

Press the **Gallery button** [22] to enter the main interface of file browsing. Select **native**, and the system will automatically display all files stored in the device's internal memory.

### SD card files

Press the **Gallery button** [22] to enter the main interface of file browsing. Select **SD card**, and the system will automatically display all files stored in the SD card.

## 7.2 Thermal image analysis

### 7.2.1 Image editing

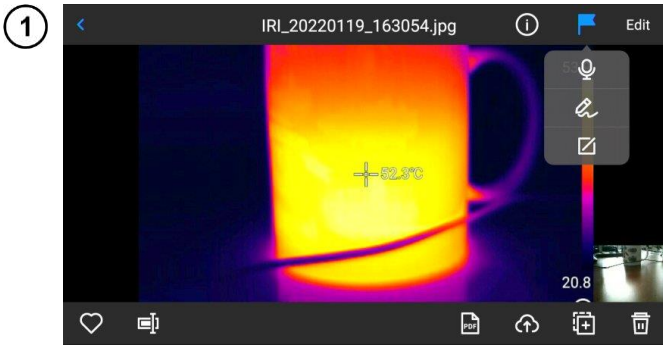

- In the Image Preview interface, click any image to enter the Image Edit interface.

- Click , and the system will automatically pop up the annotation menu, where you can perform voice and text annotation on the current image.

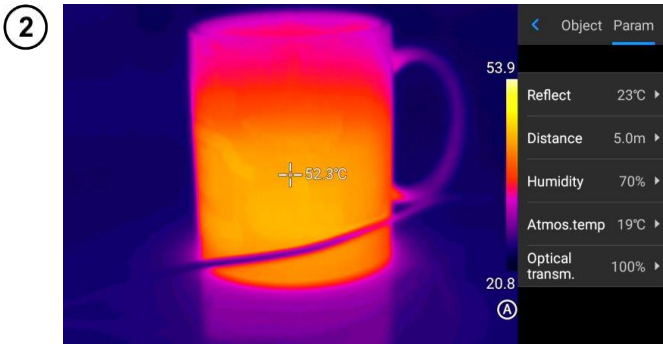

- Click the **Edit** button to add and modify the analysis object the current image, as well as modify isotherm and temperature difference between two points.

- Click **Parameter** to modify other attributes.

- Save the settings after exiting.

#### Parameter introduction

**Reflection temperature.** Editable by the user. The value range: -40...2000.

**Target distance.** Editable by the user. The value range: 0...100.

**Relative humidity.** Editable by the user. The value range: 0...100.

**Atmospheric transmittance.** According to the input distance, atmospheric temperature and relative humidity, the calibration test temperature value range is between 0...100.

**Optical transmittance.** According to the built-in temperature sensor, the drift and gain of the temperature around the detector (including the temperature change of the instrument itself) are continuously and automatically checked, and the value range is 0...100.

## 7.2.2 Image zoom

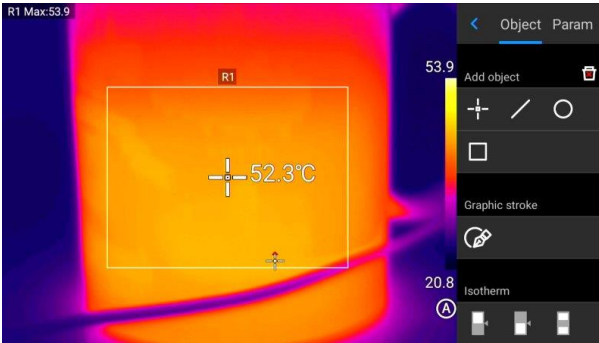

- In the image editing mode, touch the screen with two fingers, and then splay them on the screen. The image will be zoomed in by up to 10 times.
- Close your fingers and the image will be zoomed out.
- When the infrared image is enlarged, the infrared image can be moved using a single finger.

## 7.2.3 Creating a PDF

①



Press the **Gallery** button to enter the gallery browsing interface, and click **Video** to enter the video interface.

②

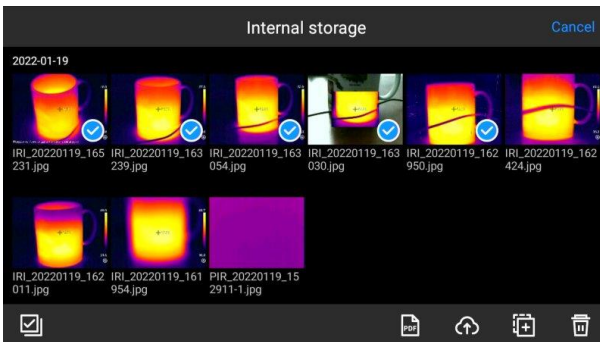

- Click the **Select** button. You can select 5 image information at will, as shown in the figure.
- Click the **PDF** button below to generate a PDF preview file.

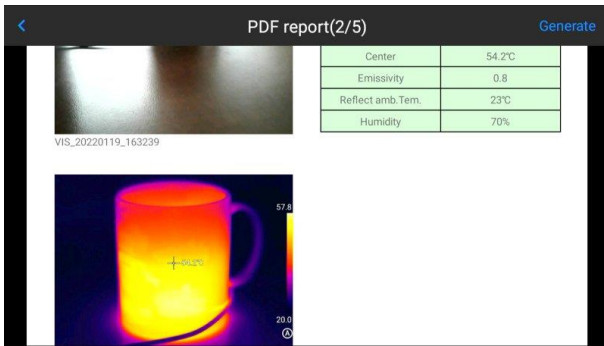

## 7.2.4 Video playback

①



Press the **Gallery** button to enter the gallery browsing interface, and click **Video** to enter the video interface.

②

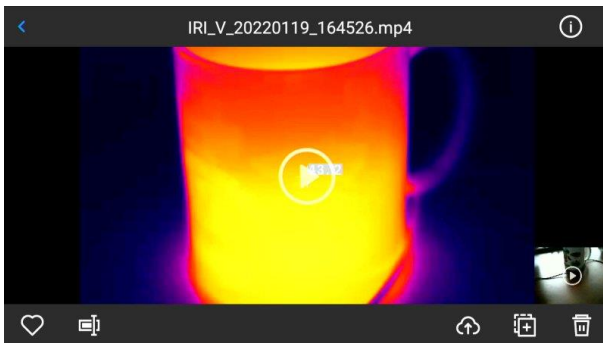

- Tap the **play** button in the center of the screen to start playing the film.
- Tap the screen to display the short film playback panel.
- To pause the video during playback, tap the **pause** button at the bottom of the screen.



## 7.3 Isotherms

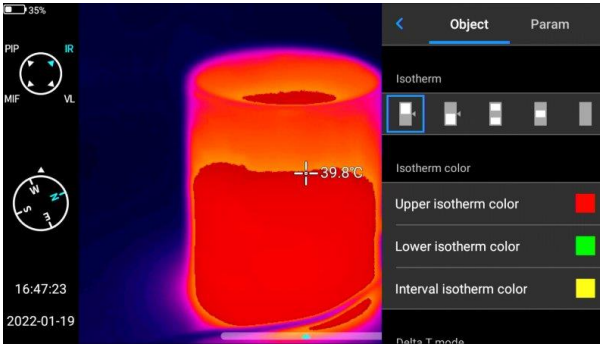

Click the shortcut menu  and slide the object interface down to the isotherm bar.



**High isotherm**  
real-time video  
image mode.

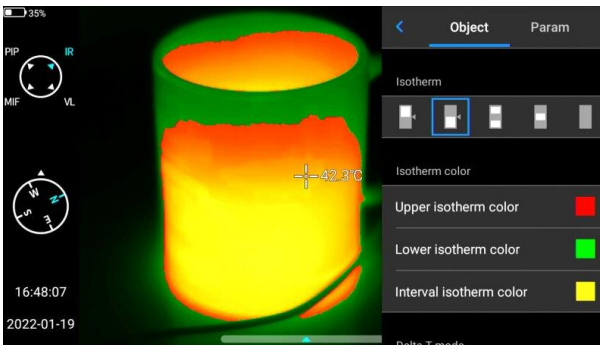

**Low isotherm**  
real-time video  
image mode.

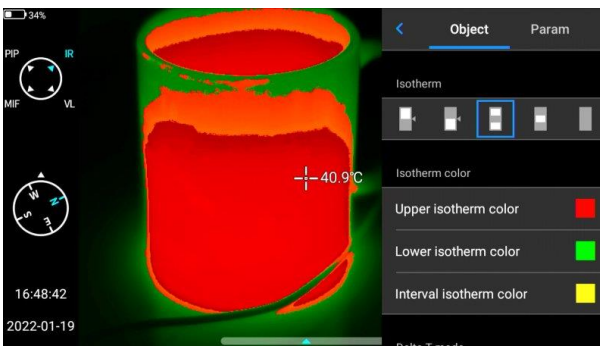

**Intra-field isotherm**  
real-time video  
image mode.

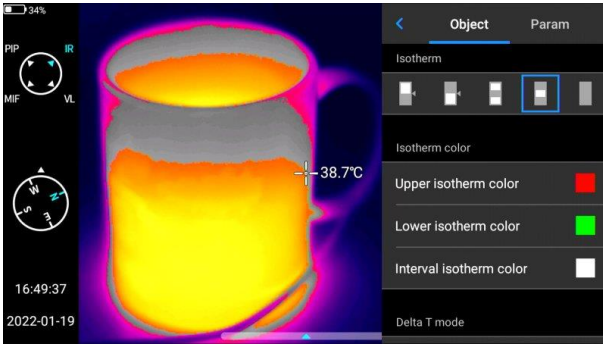

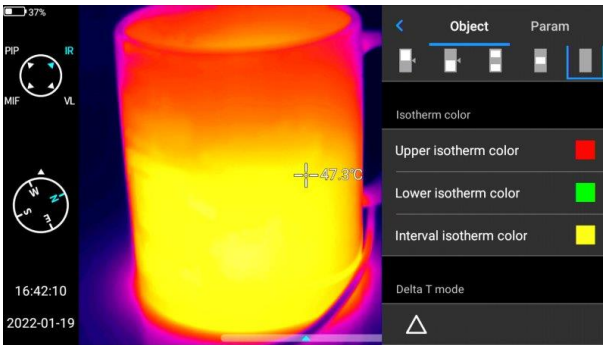

**Extra-field isotherm** real-time video image mode.

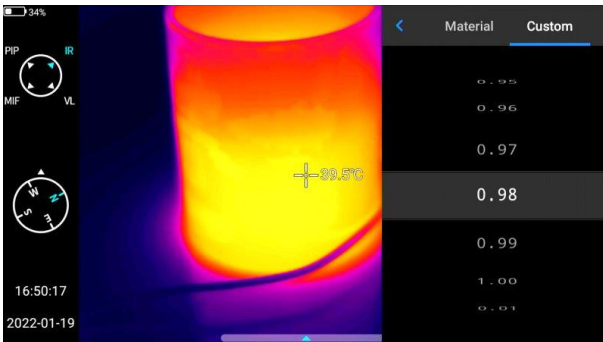

Turn off the isotherm display.

## 7.4 Custom emissivity



- Click to enter emissivity, and select **Custom**.
- Customize the parameters according to your own requirements. Slide the corresponding values to modify them.
- Click the  button to exit and save.

## 8 Settings

In the real-time video interface, click the **Settings** button .

### 8.1 Search

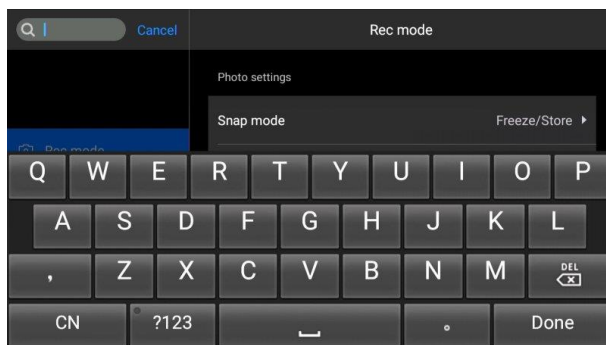

- Click the **Search** button in the upper left corner to search the parameters to be set using keywords.
- After user has set the required parameter settings, click the **Cancel** button to return to the higher-level setting interface.

### 8.2 Temperature alarm

The **alarm temperature thresholds** contain high temperature and low temperature.

The **alarm temperature value** is the value of the currently set temperature measurement range.

Turn on the **high temperature alarm** switch to set the alarm temperature threshold (e.g. 35.6°C) as required. Return to the real-time video interface. If the temperature in the scene is higher than 35.6°C, the equipment will give an audible alarm. Click the alarm icon to immediately turn off the high temperature alarm sound.

Turn on the **low temperature alarm** switch to set the alarm temperature threshold (e.g. 30.2°C) as required. Return to the real-time video interface. If the temperature in the scene is lower than 30.2°C, the equipment will give an audible alarm. Click the alarm icon to immediately turn off the low-temperature alarm sound.

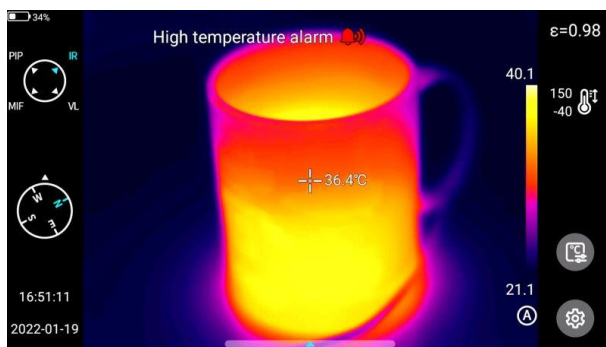

When the high-temperature alarm and low-temperature alarm switches are turned on at the same time, in order to ensure that the system is able to detect the set high-temperature alarm value, the low-temperature alarm value should not be higher than the high-temperature alarm setting.

### 8.3 Image marks

Here you can find the GPS information, compass information, date, time, cursor, logo and color band provided by the system. The user may enable part or all of the displayed information according to requirements.



By default, the tracking modes of high temperature, low temperature and average temperature in the control real-time screen are not active.

### 8.4 Image watermark

Here you can enable some watermark options, including logo watermark, date watermark, humidity watermark, GPS, orientation, emissivity, emission temperature and target distance watermark.

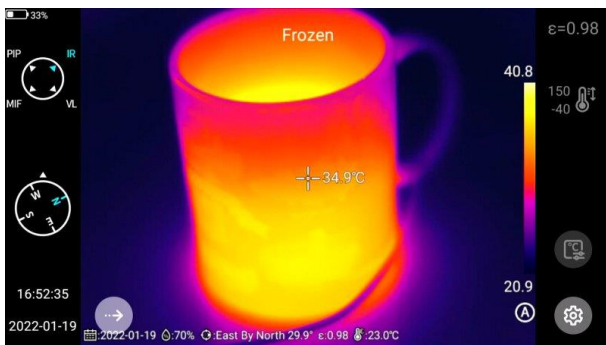

Take an example image and display it in the **Gallery**. All the watermark information that has been turned on will be displayed at the bottom of the preview.

### 8.5 Key assist

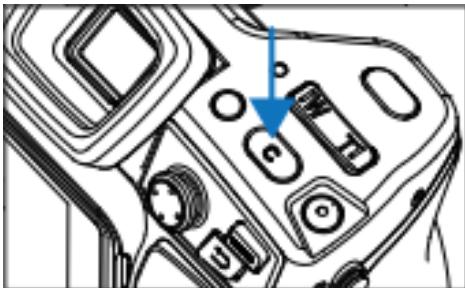

Sets the **C** button for quick operation, including task management, shutter compensation, replacement of color band, etc.

### 8.6 Unit switch

You may switch the temperature units of Celsius, Fahrenheit and Kelvin displayed by the system as required.

There are three distance units to choose from: meters, yards and inches.

## 8.7 Save parameters

For the resolution setting of visible light image, there are three options, which are only applicable to infrared mode and visible light mode. In PIP and MIF mode the resolution is 640x480.

## 8.8 Laser ranging

Enable the laser ranging function and go back to the live mode. The distance information will be saved on the picture taken using the trigger button.

## 8.9 Report parameters

Several PDF report parameters can be modified, including logo, header, footer and PDF template.

## 8.10 Preference settings

Users may add global preferences according to their own operating habits, and can also change and delete preferences. The default of the system is: default preference (except that the color band can be adjusted, other parameters should be consistent with the factory values).

## 8.11 Password lock

Users may utilize the password protection function in device startup according to their own operating habits.

## 8.12 Shutdown and sleep

- Set the automatic sleep option. Options: 1 minute, 5 minutes, 15 minutes, never.
- Set the option of automatic shutdown. Options: 5 minute, 10 minutes, 30 minutes, 60 minutes, Never.

## 8.13 Cloud service

Users may register/log in to **Cloud service** depending on their own needs, upload pictures on this device to the server, or download them through ThermoAnalyze 3 software, analyze and share them.

## 8.14 Wi-Fi

- Select a network. Click on one of the listed networks and (if necessary) enter the password.
- Connect the network after the password is successfully inputted.



In order to ensure the reliable connection of Wi-Fi signals and stable data transmission, please try to ensure that the connection distance is within 10 m and there are no obstacles.

## 8.15 Network connections

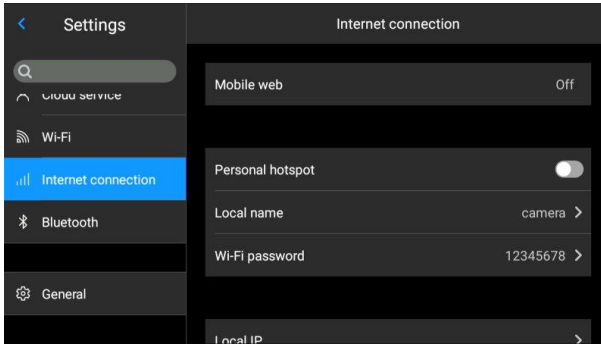

### Mobile network:

This device supports external 4G mobile networks.

1

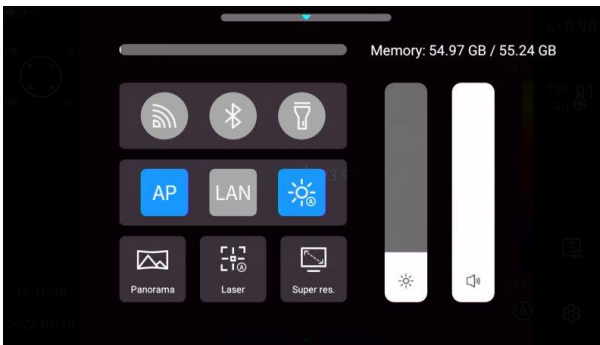

### Wi-Fi hotspot:

- In the configuration interface, enter a valid hotspot name (i.e. Camera) and password (i.e. 12345678), and click OK to save.
- Then return to live mode and pull up to pop up the shortcut menu. Enable AP function.

2

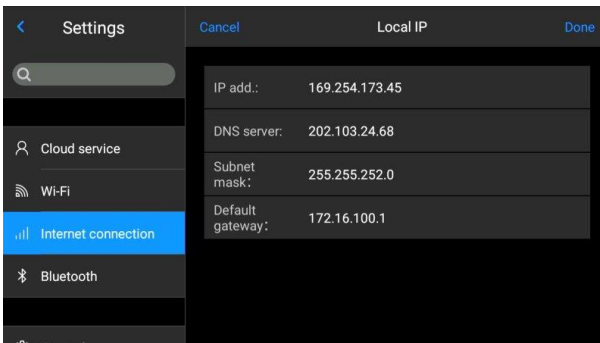

After the AP is successfully enabled, the user may enter the correct user name and password using his Bluetooth app. Then the device network can be connected successfully and images from live mode can be displayed.

## Native IP:

Users may set the IP address and DNS server address by themselves.

Właściwości: Protokół internetowy w wersji 4 (TCP/IPv4)

Ogólne

Przy odpowiedniej konfiguracji sieci możesz automatycznie uzyskać niezbędne ustawienia protokołu IP. W przeciwnym wypadku musisz uzyskać ustawienia protokołu IP od administratora sieci.

Uzyskaj adres IP automatycznie

Użyj następującego adresu IP:

Adres IP: 172 . 16 . 14 . 230

Maska podsieci: 255 . 255 . 255 . 0

Brama domyślna: 172 . 16 . 14 . 1

Uzyskaj adres serwera DNS automatycznie

Użyj następujących adresów serwerów DNS:

Preferowany serwer DNS: 202 . 103 . 24 . 68

Alternatywny serwer DNS: 222 . 103 . 24 . 68

Sprawdź przy zakończeniu poprawność ustawień

Zaawansowane...

OK Anuluj

- **IP address.** Enter a valid IP address (such as 172.16.14.216) and DNS server address 202.103.24.68. Please set the IP address and DNS address by yourself according to the local area network situation of the user. (Note: IP address cannot be set for the 192.168.42.xxx network segment, which will be prompted as “illegal IP address”).
- **Host IP.** Set the local connection IP address of desktop computer as 172.16.14.230, and DNS as 202.103.24.68. Then it can be used together with supporting software\*.

\*It needs to be used together with PC-side application software

## 8.16 Bluetooth

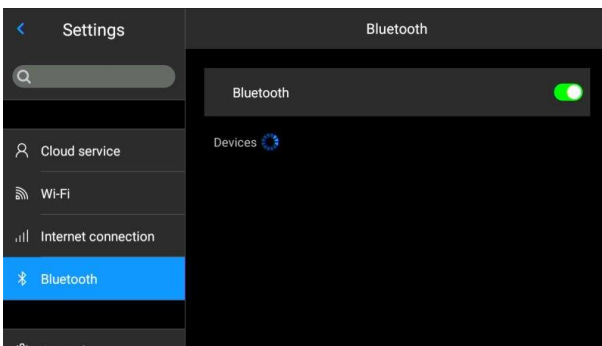

- Turn on a Bluetooth headset, press and hold the Call Button for 3 seconds to enter the pairing mode. (The blue indicator lights up continuously and stays for 3 minutes.)
- Go to **Settings ► Bluetooth**, turn on the Bluetooth setting switch, and then the system will automatically search for Bluetooth devices. Select Bluetooth headsets in the device list for pairing.
- After pairing, the headset will try to reconnect every time it is turned on.

## 8.17 General

Users may check the version and serial number of native software through **Settings ► General**, and may change information such as language, time, date and storage path.

## **8.18 Storage**

The main display contents are the remaining capacity of the internal storage device and the basic information of the external SD card. Users may also customize the storage options, including internal storage and external SD card storage.

Select storage medium: enter the device storage interface, and the user may select memory storage device or SD card for data storage.

## **8.19 License information**

It mainly displays the software list of the third party used by this device.

## **8.20 Date and time**

Manually set the system date and time.

## **8.21 Language**

Multiple languages are available for switching

## **8.22 Synchronous data**

Insert SD card to synchronize with local data.

## **8.23 Format SD card**

To start formatting, you have to select a memory card slot, and then select Yes. Please note that formatting will permanently delete all photos and other data on the memory card in the selected slot. Be sure to back up as needed before formatting.

## **8.24 Recovery**

This function will restore the device to the factory state. Please handle it carefully. Go to **Settings** ► **General** ► **Recovery**, and click **Restore Settings**.



## 9 Accurate temperature measurement

Temperature measurement accuracy depends mainly on the below factors. During the measurements the camera undertakes corrections based on signals read from the sensors. In some situations and for some materials it may be necessary to the adjustments manually. It must be remembered that there are three basic measurement parameters, that can't be changed after capturing an image:

- **focus** – images that are out of focus are not only blurred, but also they don't carry accurate temperature indications,
- **framing** – it is essential that an image is properly framed, so the object and all its necessary parts are within the frame. Otherwise the picture may be of little or no use,
- **temperature range** – If the temperature of the object, or its part, exceeds the temperature range that is set in the camera, it may not be possible to later determine the exact temperature of this area.

When all the above parameters have been considered, then the next important step is to properly configure the measurement parameters. The following section is a simplified description of each parameter and their impact on the measurement results.

**Emissivity.** Infrared measurements base on receiving the infrared radiation emitted by objects. The amount of radiation energy is based on two main factors: surface temperature and emissivity of the object's surface. Considering that surrounding object are, in most cases, not transparent for infrared radiation, to simplify the measurements, it is assumed that the radiation that reaches the object is divided into:

- emitted – radiation emitted directly by the measured object,
- reflected – the ambient radiation reflected from the surface of the measured object.

For the camera, the sum of the emitted and reflected radiation equals 1. The ration of the reflected and the emitted radiation is described by the emissivity coefficient.

For example, if the emissivity is set to 0.2, then the camera (to put it in simple terms) assumes that 20% of the radiation coming from the measured object is emitted by the object itself, and 80% is the reflected radiation. Considering the above, a special algorithms calculate the correct surface temperature of the measured object.

Exemplary values of emissivity coefficient for selected materials are presented in the emissivity table. Poorly chosen value of the emissivity coefficient may cause significant temperature reading errors. And for that reason the camera allows to adjust the value of the coefficient in the range of 0.01 ... 1.00.

Measurement accuracy also depends on **the ambient temperature** (also known as the reflected temperature). By default, the temperature measured by the camera is used, however it should be remembered that ambient temperature is neither the temperature of the air surrounding the camera, nor the temperature of the measure object itself. The ambient temperature is the temperature of the object (the energy emitted by the object), which is reflected on the surface of the object being measured. In order to maintain accuracy of measurements, proper value of ambient temperature should be accounted for – **especially, if the emissivity coefficient is changed or these changes will be performed by processing a thermal image with computer program.** This value should be changed manually in order to determine proper relation of the examined object temperature and the surrounding temperature.

The influence **of the distance** from the object on the measurement accuracy may be significant, depending on the medium in which the object is located (air, fog, smoke ...) and its impact on the attenuation of thermal radiation. It is possible to adjust this value.

**Relative humidity** may also influence the accuracy of measurement, it is possible to change the default value for any value from the range of 0...100%.

**Wind** (air flow) is another factor influencing the measurement of the object's temperature, as it cools the surface of an object altering its temperature. Pictures should not be taken in strong wind.

Additionally, to achieve an accurate temperature readout, hold the camera steady. It is recommended to carry out the auto-calibration of the camera, before starting to capture images.

## 10 Port connection

### 10.1 Micro HDMI port

The Micro HDMI interface is mainly used for connecting the external HD monitor. Please ensure that all monitors to be connected have HDMI ports.

- 1 Connect the HDMI cable to the camera.
- 2 Let the < HDMI > logo of the Micro HDMI plug facing the front of the device and insert the plug.
- 3 Connect the HDMI cable to the HDMI IN port of the HD monitor.
- 4 Turn on the HD monitor and switch its video input to select the connected port.

### 10.2 USB port

#### View internal storage files

After connecting the USB data cable to the desktop computer, open **My Computer**, check the information of the internal storage disk, click to enter the memory device, and find the folder where the images are stored. The specific path is ...\\CAMERA\\ internal storage device \\DCIM\\GCamera\\SourceImage.

#### View the SD card files

If you want to save the images in SD card, please navigate to **Global Settings ► Information ► Storage Space**, select SD card as the storage medium, and then files can be saved in the memory card after photographing.

Connect to the computer with the USB data cable, open **My Computer**, view the information of the internal storage disk, and click to enter the memory device. The path is ...\\CAMERA\\SD card \\DCIM\\GCamera\\SourceImage



The file name with the initial letters of IRI is the infrared image, and the file name with the initial letters of VIS is the visible image.

### 10.3 LAN port

- 1 Connect the network cable interface of desktop computer with the network port of this device, and ensure the status is normal.
- 2 Navigate to **Global Menu ► Connection Settings ► Device IP**, and the user can manually set relevant parameters. Enter the correct IP address and DNS address. See **section 8.15** for details.
- 3 Enter the main interface, open menu options, and click  button to enable LAN connection.



- 4 Run **ThermoAnalyze 3**, enter the video analysis interface, select the device model and enter the correct IP address.
- 5 Successfully connect with the device and display the real-time picture correctly.



After opening the **ThermoAnalyze 3** software and infrared video successfully through the network cable (Wi-Fi), the infrared video will be disconnected after clicking the system setting shortcut button on the touch screen of the device to enter the system setting. If it needs to be used continuously, it needs to be reconnected.

## 11 SD card

SD card can be used in this device, and the shot images and videos can be recorded on this device or SD card. This device supports SD cards with a maximum capacity of 64 GB. Make sure that the write protection switch of the memory card is set in the upper position to allow writing/deleting.

### 11.1 Installing SD card in the camera



#### NOTE!

Turn off the camera before installing SD card.

①

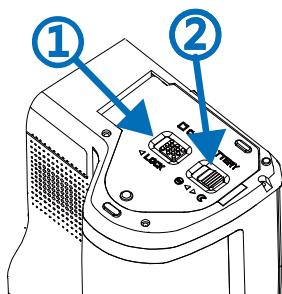

To install an SD card in the camera, unlock the security lid by sliding the latch on the compartment lid (1) and then open the lid by pulling the second latch (2).

②

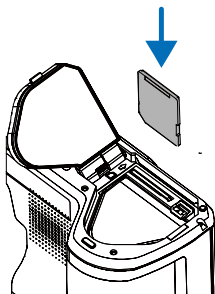

Now insert the memory card into the SD card slot until a clicking sound is heard.

③

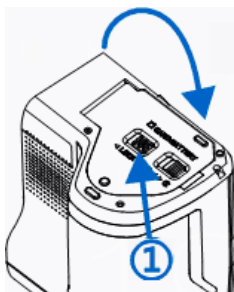

Close the lid and lock it with the latch (1). The card is now installed. The camera can be turned on.

## 11.2 Removing SD card



### NOTE!

Turn off the camera before removing SD card.

①

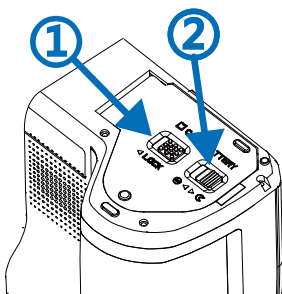

To remove SD card from the camera, unlock the security lid by sliding the latch on the compartment lid (1) and then open the lid by pulling the second latch (2).

②

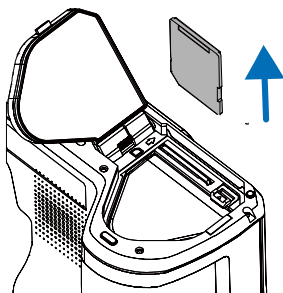

Next, insert and press the SD card deeper into its slot, until it clicks and then release the pressure. The card is now partially ejected and can be removed.

③

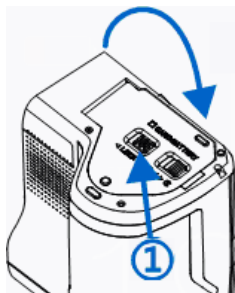

Close the lid and lock it with the latch (1). The card is now removed.

## 12 Replacing the lens



### NOTE!

It is advised to turn off the camera before replacing the lens.

①

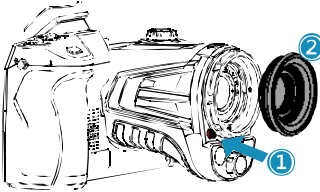

Press the Change Lens button, rotate the lens decorative cover clockwise to remove the lens decorative cover.

②

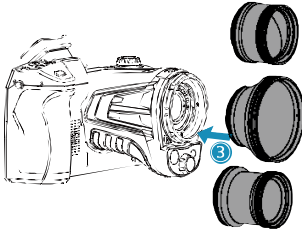

Select the lens to be extended, align the U-shaped groove of the lens with the red dot on the device standard lens, and then insert the extended lens.

③

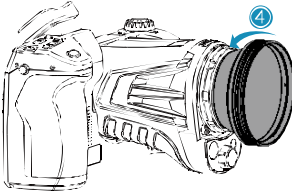

Rotate the extended lens counterclockwise until hearing the “click” sound, indicating that the lens is installed successfully.

④

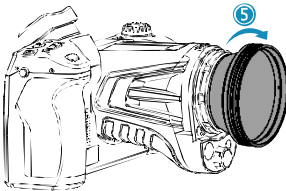

In order to remove the extended lens, press the Change Lens button, rotate clockwise as shown in the figure, and remove the extended lens.



### NOTE!

- Handle with care to avoid direct collision and lens damage;
- When not in use, please place the extended lens in a safety box and keep it properly.
- Do not touch or expose the internal parts of the camera to prevent them from fouling.

## 13 Power supply and battery charging

- The camera is powered by Lithium-ion battery. It can also be powered from the mains through the AC adapter.
- The battery can be charged while being inside of the camera. The device is also supplied with a spare battery.
- Connect the AC adapter to the [17] socket to start charging procedure.
- Charging can be performed only when the camera is not being used.
- During camera operation, current power supply source indicator is displayed in the upper left corner of the screen.



- battery power supply



- mains power supply

### 13.1 Using AC adapter

The LED light, which is located on the on/off button [12], indicates when the AC adapter is connected. When the camera is turned on, the indicator shows battery charging status, flashing red while charging and lit green when fully charged.

### 13.2 Battery power supply

During camera operation the battery charge level is being shown in real time.

### 13.3 Charging batteries

When the camera is turned off, connecting the AC adapter and starting the charging procedure is signaled by the LED charging indicator, embedded in the camera on/off button [12] – flashing red while charging and lit green when fully charged. When the battery is not being charged the indication is turned off.

Li-Ion battery does not require performing full charge-discharge cycles during exploitation, however **it is advised to perform 3 full charge-discharge cycles when using it for the first time**, and to perform one full charge cycle at least once in a several charge-discharge cycles.

The camera comes along with 2 batteries, which are advised to be used alternately. When using the second battery, the first one should be charged.



#### NOTE!

- Use only the battery, AC adapter and the external battery charger supplied with the camera.
- Do not remove the battery from the camera while it's being charged.
- Battery charging should be performed in 0...40°C ambient temperature range.
- In order to maintain the proper parameters of the batteries, charging of unused batteries should be repeated every 3 months.

## 13.4 Charging the battery in the external battery charger



### NOTE!

Turn the camera off before removing the battery.

To remove the battery from the camera, unlock the security lid by sliding the latch on the compartment lid (1) and then open the lid by pulling the second latch (2):

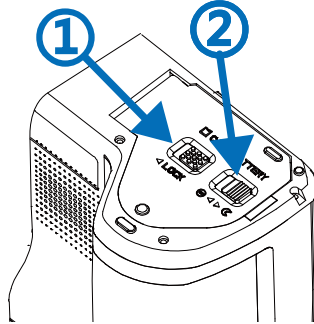

Push the battery lock lever above the battery and the battery will partially slide out of the compartment, allowing to remove it. Now the battery can be charged in the external battery charger (optional).

To put the battery back into the camera, follow the instructions for removing the battery in reverse order.



## **13.5 General rules of using Lithium (Li-Ion) batteries**

If the device is unused for an extended period, remove the battery and store it separately. The battery stored in state of deep discharge can get permanently damaged.

The battery should be stored in dry, cool and well-ventilated place and it should be protected from exposure to direct sunlight. If the battery is stored for an extended period at a location with high temperature in it, then the chemical processes occurring within it may shorten its expected life span.

Do not charge and use Li-On batteries in extreme temperatures (don't overheat and don't expose the batteries to very low temperatures). Extreme temperatures decrease battery life. Avoid placing devices powered with rechargeable batteries in very warm/hot places. Their nominal working temperature must be strictly observed.

Li-Ion cells are vulnerable to mechanical damages. Such damages can contribute to permanent damage of those type of batteries, and thus the ignition. Any interference in the structure of the battery may lead to its damage. Shorting poles (+ and -) of the battery may cause permanent damage and auto-ignition of the battery.

Do not immerse the Li-Ion batteries in liquids, do not store them in conditions of high humidity.

In case the electrolyte, that is filling the inside of the Li-Ion battery, makes direct contact with eyes or skin, rinse them with a large amount of water and contact your doctor immediately. The battery should be used in a way that makes it beyond access for random people. Keep it away from children.

Whenever any changes in Li-Ion battery is observed (different color, swelling, excessive temperature), it must cease to be used. Mechanically damaged, overcharged or deeply discharged batteries are not suitable for use.

Improper use of the battery can cause its permanent damage. It can lead to its spontaneous combustion. The seller and the manufacturer shall not be liable for any damages resulting from improper handling of the Lithium-Ion battery.

## 14 Troubleshooting

Phenomena	Cause	Measures
Unable to start.	Low battery.	Recharge the battery before use.
	Poor battery contact.	Take out the battery and put it back in place in the battery housing.
	Plug of the external power supply not in place.	Remove the power plug and reinsert it in place.
Great deviation between the battery power indication and the actual use.	Battery runs out.	Replace it with a fully charged battery.
	Expiration of battery life.	Replace with a new battery.
Unclear infrared images.	Failure in focusing.	Focus manually or automatically to make images clear.
	Lens fogged or contaminated.	Use professional equipment to clean the lens.
Unclear visible light images.	Dark environment.	Take appropriate lighting measures.
	Front end of visible light fogged or contaminated.	Use professional equipment to clean the front end of visible light.
Inaccurate temperature measurement.	Failure in focusing on the target.	Focus manually or automatically to make the image clear, and then read the temperature.
	Wrong parameters related to temperature measurement.	Change the parameter setting, or directly restore the default parameter value.
	Failure in non-uniformity correction for a long time.	Set the Customize button as compensation in the menu, press the physical Customize button and perform a non-uniformity correction when you hear the shutter sound.
	Temperature measurement immediately after start.	To ensure the accuracy of temperature measurement, you are recommended to wait for 5 to 10 minutes after turning on the thermal imager and before temperature measurement.
	Failure in calibration for a long time.	To obtain accurate temperature measurement results, you are recommended to send the thermal imager back for calibration once a year.

# 15 Specifications

Model	KT-560	KT-650	KT-670
<b>Camera</b>			
Detector resolution	384 x 288 / 17 µm	640 x 480 / 17 µm	
Spectral range	7.5–14 µm		
Frame rate	30 Hz		
Thermal sensitivity	45 mK	40 mK	35 mK
Focus	Manual / Auto		
<b>Lens (field of view / focal length / instantaneous field of view / min. focus distance)</b>			
• standard	24.9° x 18.7° / 15 mm / 1.13 mrad / 0.4 m	24.6° x 18.5° / 25 mm / 0.68 mrad / 0.3 m	
• wide angle	48.1° x 35.9° / 7.78 mm / 2.19 mrad / 0.15 m	45.4° x 34.8° / 13 mm / 1.31 mrad / 0.15 m	
• telephoto	11.2° x 8.4° / 33 mm / 0.52 mrad / 2 m	11.3° x 8.5° / 55 mm / 0.31 mrad / 1.5 m	
• ultra-telephoto	7.3° x 5.5° / 50.7 mm / 0.34 mrad / 4 m	7.3° x 5.5° / 85 mm / 0.2 mrad / 4 m	
• macro	23.3 mm x 17.5 mm / 67 mm / - / 60.7 µm	23.3 mm x 17.5 mm / 67 mm / - / 37.5 µm	
• high temp	24.9° x 18.7° / - / - / -	24.6° x 18.5° / - / - / -	
<b>Image</b>			
Display	5", 1280 x 720 high brightness, LCD touchscreen		
Viewfinder	1280 x 960 LCOS		
Image modes	IR / Visual / Infrason MIF/PI/P		
Digital Zoom	1...10	1...35	
<b>Temperature measurement</b>			
Temperature range	Range 1: -40°C...150°C Range 2: 100°C...800°C Optional: 700°C ...2000°C		
Accuracy (Ambient: 15°C ...35°C, object: >0°C)	±2°C or ±2% of reading		±1°C or ±1% of reading
<b>Functions</b>			
Image analysis modes	12 points, 12 lines, 12 areas. Temperature indication: min, max, average. Isotherm. Tem- perature alarm. Smart stroke.	16 points, 16 lines, 16 areas. Temperature indication: min, max, aver- age. Isotherm. Temperature alarm. Smart stroke.	
Palettes	8	10	12
Super-resolution	4x, 768 x 576	4x, 1280 x 960	
Panoramic images	-	√	
Emissivity coefficient	Selectable from 0.01 to 1.00		
Measurement adjustment	Auto-adjustable distance, relative humidity, ambient temperature (reflected)		
File format	JPG		
IR image annotations	Additional visual photos, voice, text recognition, text typing		
Reports module	PDF reports		
Video file format	MP4 (without temp. information), IRGD (including temp. information)		
Built-in features	Visual camera 13 MPix, LED flashlight, GPS, laser pointer, laser rangefinder, microphone, speaker, digital compass, light sensor.		
Wireless communication	Wi-Fi, Bluetooth		
Storage	Built-in memory (64 GB), SD card, cloud service		
Interface	SD card slot (max. 64 GB), LAN 1 Gb/s, micro HDMI, USB type C (data transfer only), tripod		
Power Supply	Li-ion battery (4 h of continuous operation), built-in charger, AC adapter 110-230 V, 50/60 Hz		
<b>Environmental conditions</b>			
Operating temperature	-20°C...50°C		
Storage temperature	-40°C...70°C		
Humidity	≤95%		
Shock/Vibration	30g 11 ms (IEC 60068-2-27)		
Encapsulation	IP54		
Weight	approx. 1.4 kg (with battery)		
Dimensions	206 x 145 x 135 mm		



SONEL S.A. hereby declares that the radio device type KT-560/650/670 complies with Directive 2014/53/EU. The full text of the EU Declaration of Conformity is available at the following website address: <https://sonel.pl/en/download/declaration-of-conformity/>

## 16 Cleaning and maintenance



### NOTE!

Use the below specified methods of maintenance only.

Camera enclosure – all surfaces, except for optical elements of the camera, can be cleaned with a soft and moist cloth with generally available mild detergents. Do not use any solvents or cleaning agents that could scratch the enclosure (powder, paste, etc.). During cleaning, the camera must be turned off.

Due to the applied anti-reflective coating, optical lens are the most sensitive and at the same time the most expensive part of the camera (the lens is of key importance to radio-metric capabilities of the infrared system). Therefore it is important to close the protective lens cover after each use of the camera. Optical surfaces should be cleaned only, when they are visibly fouled. Do not touch exposed surfaces of optical lens with fingers, because fouling left with fingerprints can be harmful to coatings and glass of the lens.

Chemical agents must not be used for cleaning the optical viewfinder, and particularly optics and accessories of the camera. Use a clean, dry and soft cloth for cleaning the body of the viewfinder; for cleaning the lens, use only the supplied lens cleaning cloth.

## 17 Service and storage

Thermal imaging cameras don't comprise any parts serviceable by the user. Do not attempt to dismantle or modify the camera on your own. Opening the instrument voids the warranty.



### NOTE!

Only the manufacturer is authorized to perform service repairs.

When storing the instrument, observe the following guidelines:

- make sure the camera and its accessories are dry,
- when storing the camera for a prolonged time, remove the batteries,
- allowed are storage temperatures specified in technical specifications,
- in order to avoid complete discharging of rechargeable batteries during prolonged storage, charge them once in a while.

## 18 Dismantling and disposal

- Used-up electrical or electronic equipment must be collected selectively, i.e. must not be mixed with waste of other types.
- Used-up electronic equipment must be delivered to an appropriate collection centre in accordance with regulations related to used-up electrical or electronic equipment.
- Before delivering the equipment to the collection centre do not attempt to dismantle any of its parts.
- Follow local regulations related to disposing of packaging, used-up batteries and rechargeable batteries.

## 19 Accessories

The current list of accessories can be found on the manufacturer's website.

### 19.1 Standard accessories

Standard bundle supplied by the manufacturer includes:

Name	KT-560	KT-650	KT-670
• Thermal imager KT-560 / 650 / 670	√	√	√
• 2 x Li-Ion battery 10.8 V 3.35 Ah – <b>WAAKU18</b>	√	√	√
• Power supply Z13 – <b>WAZASZ13</b>	√	√	√
• External battery charger Z14 – <b>WAZASZ14</b>			√
• Type C USB cable – <b>WAPRZUSBC</b>	√	√	√
• LAN cable (RJ45) – <b>WAPRZRJ45</b>	√	√	√
• Micro HDMI cable – <b>WAPRZMIKROHDMI</b>	√	√	√
• SD card 64 GB – <b>WAPOZSD64</b>	√	√	√
• Shoulder harness – <b>WAPOZPAS3</b>	√	√	√
• XL9 carrying case – <b>WAWALXL9</b>	√	√	√
• Lens cover	√	√	√
• User manual	√	√	√
• Factory calibration certificate	√	√	√

## 19.2 Optional accessories

- High temperature filter  
2000°C

**WAADAOF1**



- Lens

Wide-angle IR lens  
48.1°×35.9°/7.78 mm  
for KT-560

**WAADAO8V560**



Wide-angle IR lens  
45.4°×34.8°/13 mm  
for KT-650/670

**WAADAO13V6701**



Tele IR lens  
11.2°×8.4°/33 mm  
for KT-560

**WAADAO33V560**



Tele IR lens  
11.3°×8.5°/55 mm  
for KT-650/670

**WAADAO55V6701**



- Power supply adaptor  
Z14 (KT-560, KT-650  
only)

**WAZASZ14**



- Adapter – converter  
HDMI / RCA

**WAADAHDMIXRCP**

- M-11 carrying case

**WAFUTM11**



- Calibration certificate with accreditation

## 20 Manufacturer

The manufacturer and provider of warranty and post-warranty services for this instrument is:

**SONEL S.A.**

Wokulskiego 11

58-100 Świdnica

Poland

tel. +48 74 858 38 60

fax +48 74 858 38 09

E-mail: [export@sonel.pl](mailto:export@sonel.pl)

Web page: [www.sonel.pl](http://www.sonel.pl)

## 21 Exemplary emissivity coefficient values

<i>aluminum</i> .....	0.05	<i>lead: polished</i> .....	0.08
<i>aluminum rough</i> .....	0.07	<i>lead: grey</i> .....	0.28
<i>aluminum oxidized</i> .....	0.25	<i>lead: oxidized</i> .....	0.63
<i>asphalt</i> .....	0.90	<i>paper white</i> .....	0.90
<i>asbestos board</i> .....	0.96	<i>paper black glossy</i> .....	0.90
<i>asbestos (fiber)</i> .....	0.78	<i>paper black dull</i> .....	0.94
<i>akelite</i> .....	0.93	<i>paper: tarred</i> .....	0.92
<i>bronze: dull</i> .....	0.22	<i>plastic: black</i> .....	0.95
<i>bronze: polished</i> .....	0.10	<i>platinum</i> .....	0.10
<i>bronze: rough</i> .....	0.55	<i>porcelain: glazed</i> .....	0.92
<i>brick: glass.. rough</i> .....	0.85	<i>mercury</i> .....	0.10
<i>brick: fireproof. rough</i> .....	0.94	<i>lampblack</i> .....	0.96
<i>cement</i> .....	0.54	<i>silver</i> .....	0.03
<i>cement (concrete)</i> .....	0.90	<i>steel: galvanized</i> .....	0.28
<i>chrome</i> .....	0.15	<i>steel: oxidized</i> .....	0.88
<i>chrome polished</i> .....	0.10	<i>steel: rolled freshly</i> .....	0.24
<i>tin</i> .....	0.09	<i>steel: rolled</i> .....	0.56
<i>zinc</i> .....	0.05	<i>steel: rough</i> .....	0.96
<i>brick red</i> .....	0.93	<i>steel: rusty red</i> .....	0.69
<i>paint: oil</i> .....	0.94	<i>steel nickeled</i> .....	0.11
<i>clay: fired</i> .....	0.91	<i>glaze</i> .....	0.90
<i>clay</i> .....	0.40	<i>glass</i> .....	0.92
<i>graphite</i> .....	0.85	<i>glass dull</i> .....	0.96
<i>ground: frozen</i> .....	0.93	<i>snow</i> .....	0.80
<i>rubber</i> .....	0.93	<i>tape insulation</i> .....	0.95
<i>cobalt</i> .....	0.18	<i>fabric</i> .....	0.85
<i>quartz</i> .....	0.93	<i>titanium</i> .....	0.30
<i>lacquer white</i> .....	0.87	<i>carbon</i> .....	0.90
<i>lacquer polished black</i> .....	0.87	<i>charcoal powder</i> .....	0.96
<i>lacquer dull black</i> .....	0.97	<i>tungsten</i> .....	0.13
<i>lacquer silver</i> .....	0.31	<i>tungsten: oxidized</i> .....	0.11
<i>ice</i> .....	0.97	<i>gold</i> .....	0.02
<i>magnesium</i> .....	0.12	<i>iron: glossy</i> .....	0.16
<i>copper: oxidized</i> .....	0.65	<i>iron: heat rolled</i> .....	0.77
<i>copper: oxidized black</i> .....	0.88	<i>iron: oxidized</i> .....	0.74
<i>copper: polished</i> .....	0.07	<i>iron: polished</i> .....	0.23
<i>copper: polished annealed</i> .....	0.01	<i>iron and steel: oxidized</i> .....	0.85
<i>brass</i> .....	0.10	<i>cast: raw casting</i> .....	0.81
<i>brass: oxidized</i> .....	0.61	<i>cast: polished</i> .....	0.21
<i>nickel: polished</i> .....	0.05		



## 22 Laboratory services

SONEL Testing and Calibration Laboratory has been accredited by the Polish Center for Accreditation (PCA) – certificate no. AP 173.

Laboratory offers calibration for the following instruments that are used for measuring electrical and non-electrical parameters.



AP 173

### ● METERS FOR MEASUREMENTS OF ELECTRICAL PARAMETERS

- voltage meters,
- current meters (including clamp meters),
- resistance meters,
- insulation resistance meters,
- earth resistance and resistivity meters,
- RCD meters,
- short-circuit loop impedance meters,
- power quality analyzers,
- portable appliance testers (PAT),
- power meters,
- multimeters,
- multifunction meters covering the functions of the above-mentioned instruments,

### ● ELECTRICAL STANDARDS

- calibrators,
- resistance standards,

### ● METERS FOR MEASUREMENTS OF NON-ELECTRICAL PARAMETERS

- pyrometers,
- thermal imagers,
- luxmeters.

The **Calibration Certificate** is a document that presents a relation between the calibration standard of known accuracy and meter indications with associated measurement uncertainties. The calibration standards are normally traceable to the national standard held by the National Metrological Institute.

According to ILAC-G24 „Guidelines for determination of calibration intervals of measuring instruments”, SONEL S.A. recommends periodical metrological inspection of the instruments it manufactures no less frequently than once every **12 months**.

For new instruments provided with the Calibration Certificate or Validation Certificate at the factory, re-calibration should be performed within **12 months** from the date of purchase, however, no later than **24 months** from the date of purchase.



### ATTENTION !

The person performing the measurements should be absolutely sure about the efficiency of the device being used. Measurements made with an inefficient meter can contribute to an incorrect assessment of the effectiveness of health protection and even human life.

## NOTES



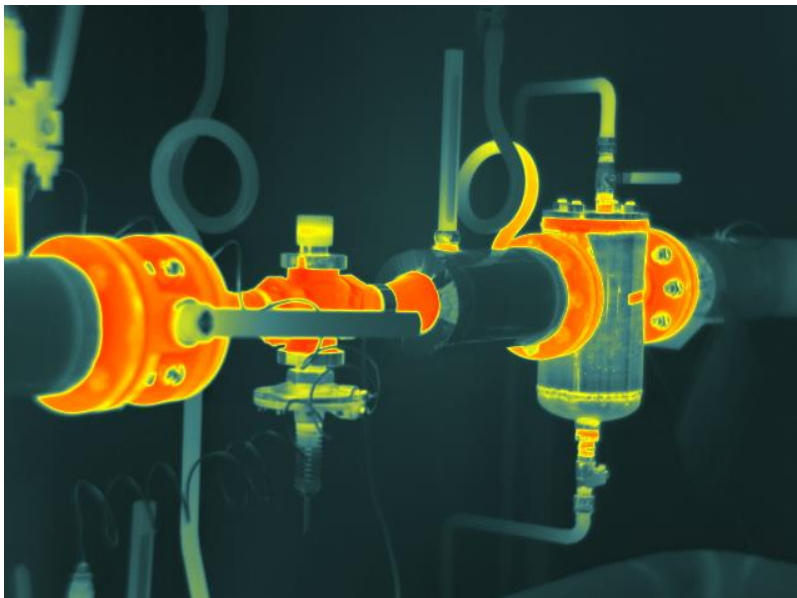

## **SONEL S.A.**

Wokulskiego 11  
58-100 Świdnica  
Poland

tel. +48 74 858 38 60  
fax +48 74 858 38 00

e-mail: [sonel@sonel.pl](mailto:sonel@sonel.pl)  
[www.sonel.pl](http://www.sonel.pl)